

**SAFETY.CAT.COM™**

# **MAINTENANCE INTERVALS**

Operation and Maintenance  
Manual Excerpt

# Operation & Maintenance Manual

---

## **D6D, D6E, and D6E SR Track-Type Tractors**

---

2MJ1158-UP  
8FJ1-UP  
7YK1-UP  
9FK1-UP

# Maintenance Intervals

## When Required

Engine Air Intake System – Service filters .....	76
Ether Starting Aid (If Equipped) – Replace .....	79
Fuses – Replace .....	79
Cutting Edges and End Bits– Replace .....	80
Ripper Tips (If Equipped)– Replace .....	81
Radiator – Clean/replace .....	81
Bulldozer Tilt Brace – Adjust .....	82
Fuel System Filters – Change .....	82
Flywheel Clutch and Brake– Adjust .....	84
Windshield Wiper/Washer (If Equipped) – Inspect/Fill .....	86
Fuel Filter Element – Bosch Fuel System (If Equipped) – Service when loss of power occurs ...	129

## Every 10 Service Hours or Daily

Walk-Around Inspection – Inspect machine .....	87
Seat Belt – Inspect .....	89
Window Cleaning .....	89
Engine Crankcase Oil – Check .....	89
Power Train Oil System – Check .....	90
Hydraulic Tank Oil – Check .....	90
Radiator – Check coolant level .....	91
Fuel Tank – Drain moisture and sediment .....	92
Indicators and Gauges – Test .....	92
Back-up Alarm (If Equipped) – Test .....	93

## Every 50 Service Hours or Weekly\*

Batteries – Check .....	94
Ripper Linkage and Cylinder Bearings – Lubricate .....	95
Cab Air System (If Equipped) – Clean filters elements .....	95
Bulldozer Cylinder Support Bearings – Lubricate ..	97
Track Roller Frame Bearings – Lubricate .....	98
Power Train Oil System – Change filter element/clean strainer .....	98
Track Pins – Inspect .....	99

## Every 100 Service Hours or 2 Weeks\*

Hydraulic Control Linkage – Lubricate .....	100
Sprocket Hub Bearings – Inspect .....	100

## Every 250 Service Hours or Monthly\*

Engine Oil and Filter – Change. If the sulfur content in the fuel is greater than 1.5 percent by weight, use an oil with a TBN of 30 and reduce the oil change interval by one half .....	101
--	-----

Cooling System – Add supplemental coolant additive/replace element .....	102
Fan Pulley Bearing – Lubricate .....	103
Air Conditioning, Fan, and Alternator Belts – Inspect/Adjust .....	103
Final Drives – Check oil level .....	105
Power Train Oil System– Change filter element/clean screen and magnets .....	105
Brakes – Check brake pedals/parking brake .....	107
Tracks – Adjust .....	108
Air Conditioner (If Equipped) – Test .....	110
Bulldozer Tilt Brace – Lubricate .....	111
Engine Valve Clearance Setting – Adjust on new or reconditioned engines at first oil change only .....	126

## Every 500 Service Hours or 3 Months\*

Hydraulic System – Change filter element .....	112
Fuel System – Change primary and secondary filter .....	113
Fuel Tank – Clean cap and fill screen .....	114
Engine Crankcase Breather – Clean .....	115
Equalizer Bar Pads – Inspect .....	116
Sprocket Hub Bearings – Inspect .....	116

## Every 1000 Service Hours or 6 Months\*

Power Train Oil System (Power Shift) – Drain oil, change filter, clean screen and magnets, Fill oil .....	117
Universal Joints – Lubricate .....	119
Rollover or Falling Objects Protective Structure/Falling Object Protective Structure (ROPS/FOPS) (If Equipped) – Inspect .....	120

## Every 2000 Service Hours or 1 Year\*

Hydraulic System – Change oil .....	121
Power Train Oil System (Direct Drive) – Drain oil, change filter, clean screen and magnets, Fill oil .....	122
Final Drives – Change oil .....	125
Engine Valve Clearance Setting – Adjust .....	126
Engine Valve Rotators – Check .....	126
Sprocket Hub Bearings – Adjust .....	127

## Every 3000 Service Hours or 2 Years\*

Cooling System – Change coolant, clean system ..	128
Fuel Filter Element – Bosch Fuel System (If Equipped) – Change .....	129

\*First Perform Previous Service Hours Items

## When Required

*You must read and understand the warnings and instructions contained in the Safety section of this manual, before performing any operation or maintenance procedures.*

### Engine Air Intake System

#### Precleaner

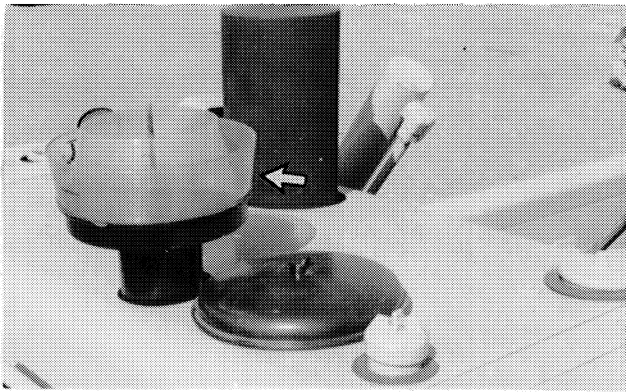

1. Inspect the cup visually. Cup should be emptied whenever dirt reaches the indicator mark.
2. Loosen the wing nut on top and remove the cover and cup. Empty and clean the cup, wipe the cover clean.
3. Install the cup and cover. Tighten the wing nut finger tight only. Do not use a tool.

#### Service Filter Elements

---

##### NOTICE

Service the air cleaner only with the engine stopped. Engine damage could result.

---

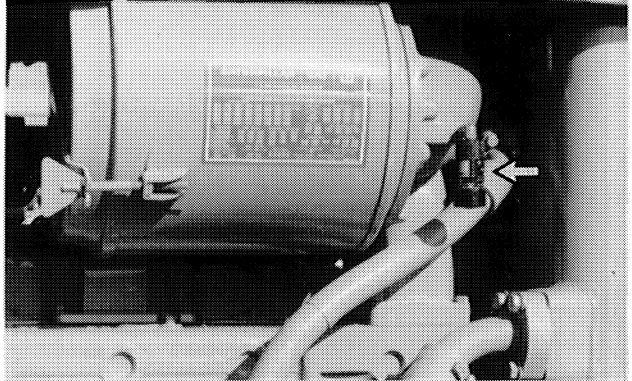

Service the air cleaner if the yellow piston in the filter element indicator moves into the red zone with the engine running at HIGH IDLE. Stop the engine.

#### Service Primary Element

1. Open the access cover (if equipped).

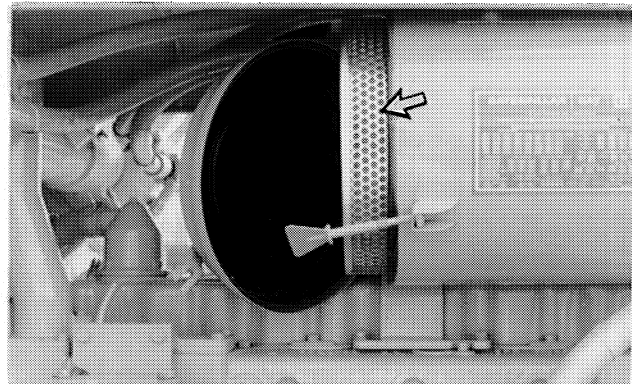

2. Remove the air cleaner cover.
3. Remove the primary filter element from the air cleaner housing.

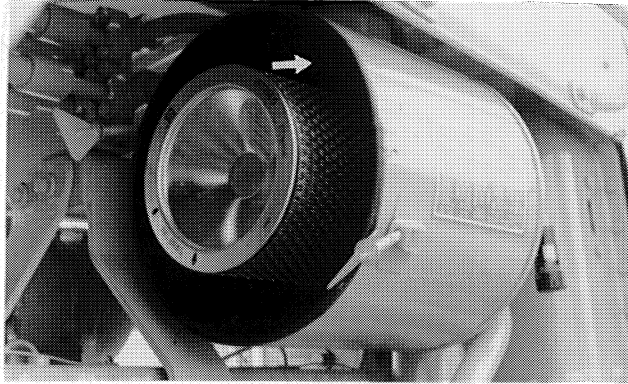

4. Clean the inside of the air cleaner housing.
5. Clean and inspect the primary element. See the topic Cleaning Primary Elements under When Required in the Maintenance Section of this manual.
6. Install a clean primary element.
7. Clean and install the cover. Tighten the cover bolts finger tight. Do not use a tool to tighten the bolts.
8. Close the access door (if equipped).

If the yellow piston in the filter element indicator moves into the red zone after starting the engine, or the exhaust smoke is still black after installation of a clean primary filter element, install a new primary filter element.

The primary element should be replaced after being cleaned a maximum of six times. Replace the element once a year even though it has not been cleaned six times.

## Replace Secondary Element

---

### NOTICE

Always replace the secondary filter element. Never attempt to reuse it by cleaning.

The secondary filter element should be replaced at the time the primary element is serviced for the third time.

The secondary filter element should also be replaced if the yellow piston in the filter element indicator enters the red zone after installation of a clean primary element, or if the exhaust smoke is still black.

---

1. Open the access cover (if equipped).

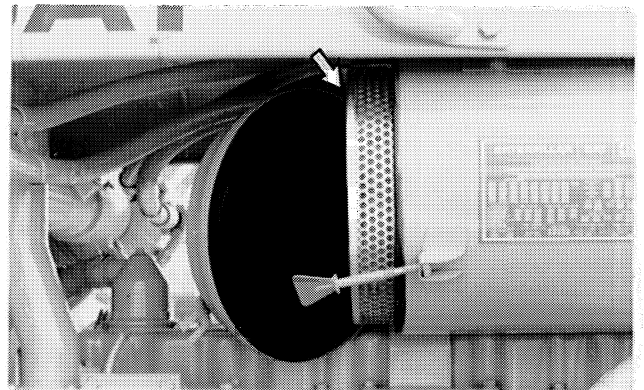

2. Remove the housing cover and the primary element.

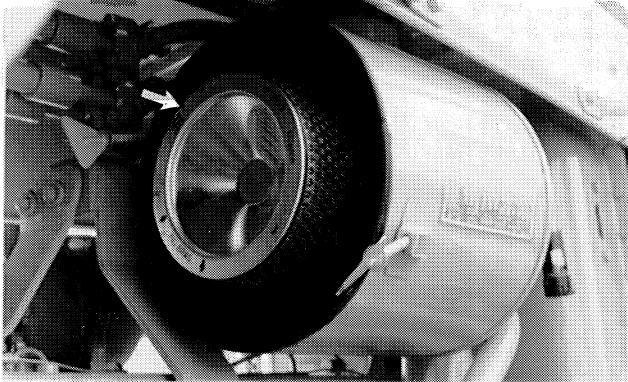

3. Remove the bolts that hold the secondary filter element to the housing. Remove the secondary element.
4. Cover the air inlet opening. Clean the inside of the air cleaner housing.
5. Inspect the gasket between the air inlet pipe and the housing. Replace it if it is damaged.
6. Uncover the air inlet opening. Install a new secondary element.
7. Install the nuts and washers on the studs. Tighten the nuts to a torque of  $27 \pm 7 \text{ N}\cdot\text{m}$  ( $20 \pm 5 \text{ lb ft}$ ).
8. Install the primary element. Install the cover. Tighten the cover bolts finger tight only. Do not use a tool to tighten the cover bolts.
9. Close the access cover (if equipped).

## Cleaning Primary Elements

---

### NOTICE

Do not clean the filter elements by bumping or tapping them. Do not use filter elements with damaged pleats, gaskets or seals. Engine damage can result.

Make sure the cleaned filter elements are completely dry before installing into the filter housing. Water remaining in the elements can cause false indications of contamination in Scheduled Oil Sampling test results.

---

Filter elements can be cleaned with pressure air - 205 kPa (30 psi) maximum, pressure water - 280 kPa (40 psi) maximum, or detergent washing.

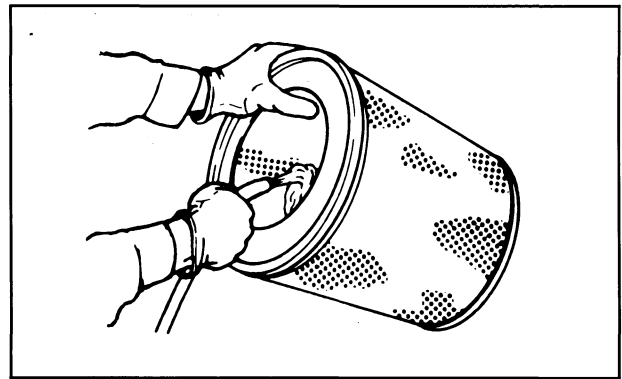

1. Direct air or water along the pleats inside and outside of filter element.

The element can be washed in warm water and nonsudsing household detergent. Rinse inside and outside the pleats and air dry fully.

2. Inspect the filter elements after cleaning. Do not use a filter element with damaged pleats, gaskets or seals.

3. Wrap and store the clean filter elements in a clean, dry place.

## Ether Starting Aid (If Equipped)

### Replace Cylinder

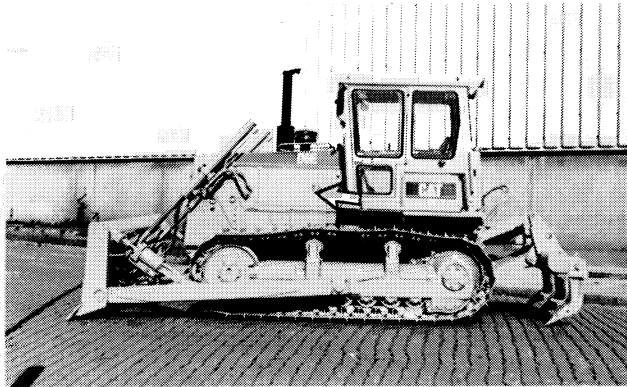

**1.** Open the engine compartment access cover (if equipped). The ether cylinder is located on the left side of the machine.

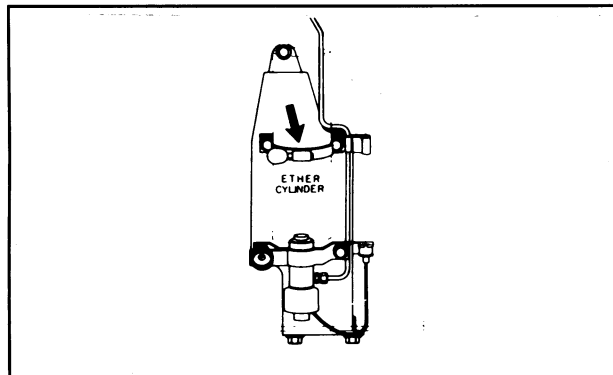

**2.** Loosen the cylinder retaining clamp, unscrew and remove the empty ether cylinder.

**3.** Remove the used gasket. Install the new gasket provided with each new cylinder.

**4.** Install the new cylinder. Tighten the cylinder hand tight. Tighten the cylinder clamp securely.

**5.** Close the access cover (if equipped).

## Fuses

### Replace

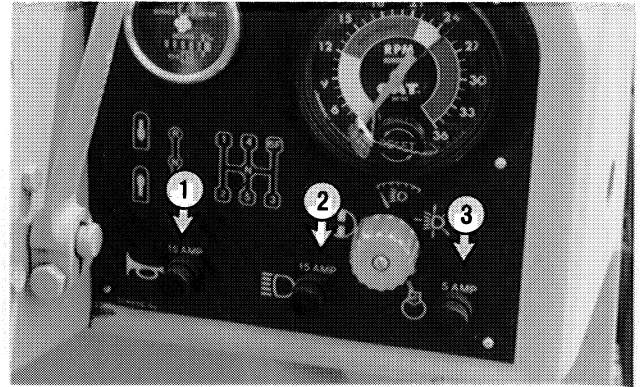

 **Fuses** – They protect the electrical system from damage caused by overloaded circuits. Change a fuse if the element separates. If the element of a new fuse separates, have the circuit checked and repaired.

---

#### NOTICE

Replace the fuses with the same type and size only. Otherwise, electrical damage can result.

If it is necessary to replace fuses frequently, an electrical problem may exist. Contact your Caterpillar dealer.

---

 Horn Fuse (1) – 15A

 Lights Fuse (2) – 15A

 Starting Aid Fuse (3) – 15A

If equipped with cab:

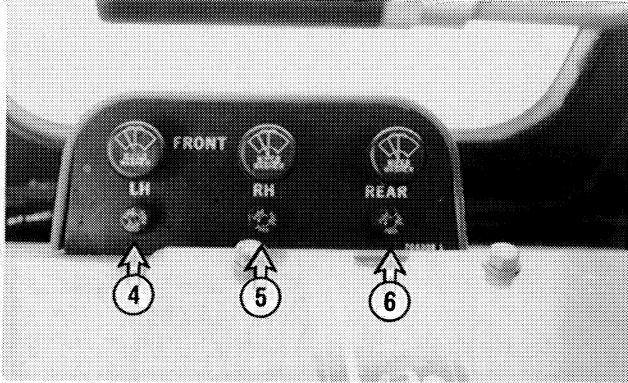

Front Left Side Wiper/Washer Fuse (4) – 15A



Front Right Side Wiper/Washer Fuse (5) – 15A



Rear Wiper/Washer Fuse (6) – 15A

## Cutting Edges and End Bits

Replace if Worn or Damaged

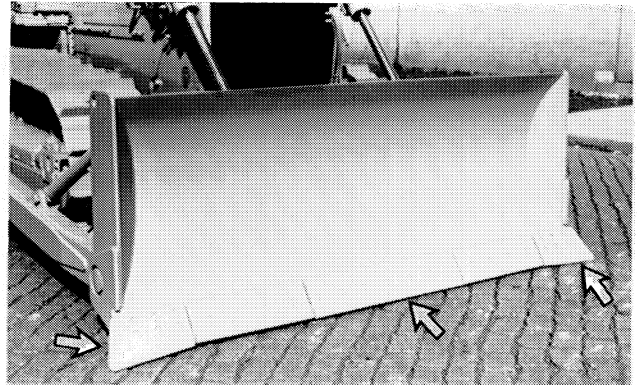

1. Raise the dozer blade and place blocking under it. Lower the blade onto the blocking. Do not block the blade any higher than necessary to remove cutting edge or end bits.
2. Remove bolts. Remove cutting edge and end bits.
3. Clean all contact surfaces thoroughly.
4. Turn cutting edge over and use the opposite edge, if it is not worn.
5. Install a new cutting edge section, if both edges are worn.
6. Repeat Steps 4 and 5 for end bits.
7. Install all bolts and tighten them to the specified torque. See the Torques for Ground Engaging Tool Bolts chart under Torque Specifications in the Maintenance Section of this manual for specified torque.
8. Raise the dozer blade and remove the blocking. Lower the blade to the ground.
9. After a few hours of operation, check all bolts for proper torque. Retorque any bolts as needed.

## Ripper Tips (If Equipped)

### Replace if Worn or Damaged

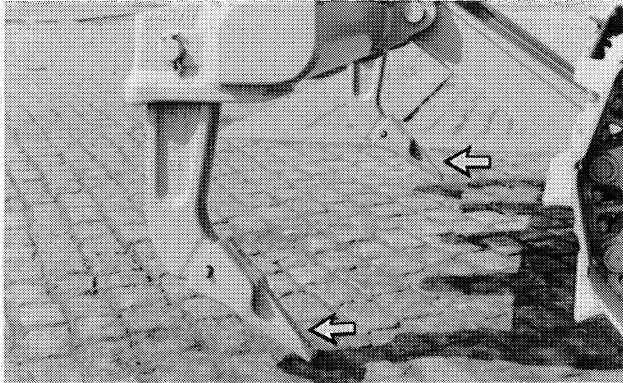

Replace the ripper tip when worn close to shank. Too blunt of a tip does not penetrate properly.

1. Raise the ripper and place blocking under it. Lower the ripper onto the blocking. Do not block the ripper any higher than necessary to remove tips.
2. If the ripper tip is worn, drive the pin out. Remove the tip and the pin retainer.
3. Clean the shank pin retainer and pin.
4. Install the new tip and retainer.
5. Install the pin in from the side opposite of the retainer.
6. Raise the ripper and remove the support.
7. Lower the ripper to the ground.

## Radiator

### Clean or Replace Pressure Cap

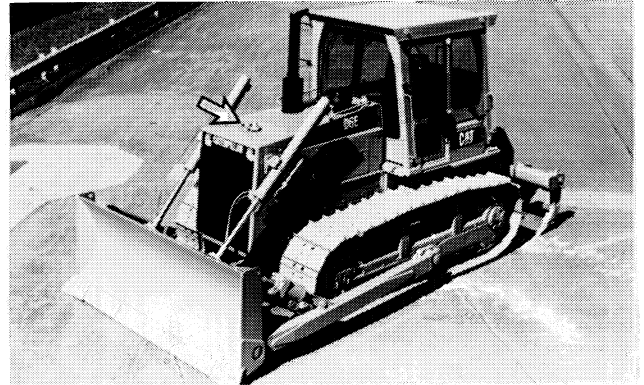

1. Remove the coolant fill cap slowly to relieve any pressure.
2. Inspect the cap for damage, deposits or foreign material. Clean the cap with a clean cloth or replace the cap if necessary.
3. Install the cap.

### Clean Core

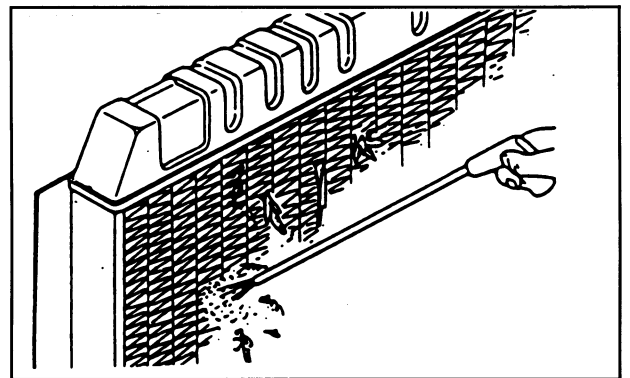

Compressed air, high pressure water or steam can be used to remove dust, leaves and general debris from the radiator core. Clean as required by condition of radiator.

The use of compressed air is preferred.

Refer to Know Your Cooling System, SEBD0518, for the complete procedure and instructions.

## Bulldozer Tilt Brace (If Equipped)

### Adjust Brace and Diagonal Arm

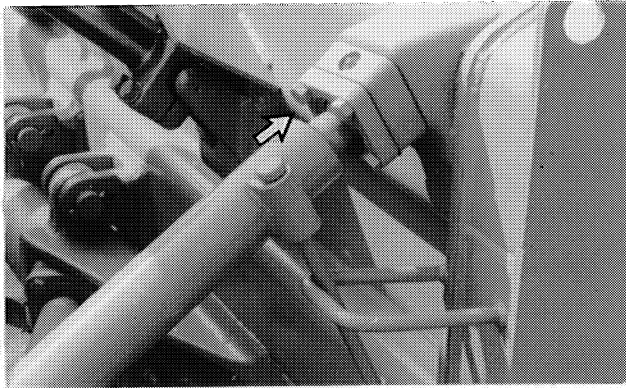

Make the following adjustment when the brace is too tight or too loose.

1. Remove the cap bolts. Turn the brace to the left to shorten the brace.
2. Remove the shim material. Clean the grease from the ball and socket and clean the shims.
3. Lengthen the brace. Install and tighten the bolts evenly.

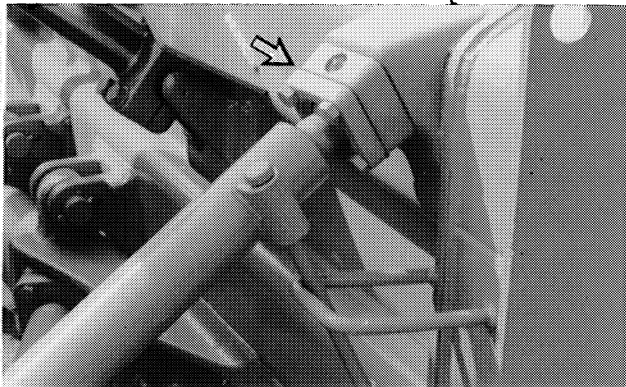

4. Measure the clearance between the cap and socket with the shims.
5. Remove the bolts and shorten the brace.
6. Install the shims equal to the measured shim clearance plus one shim.
7. Lengthen the brace and install the bolts. Tighten the bolts to a torque of  $205 \pm 25 \text{ N}\cdot\text{m}$  ( $150 \pm 20 \text{ lb ft}$ ).
8. Lubricate the ball and socket.

## Fuel System Filters

### Change

---

#### NOTICE

Do not fill fuel filters with fuel before installing them. Contaminated fuel causes accelerated wear to fuel system parts.

---

### Change Primary Filter

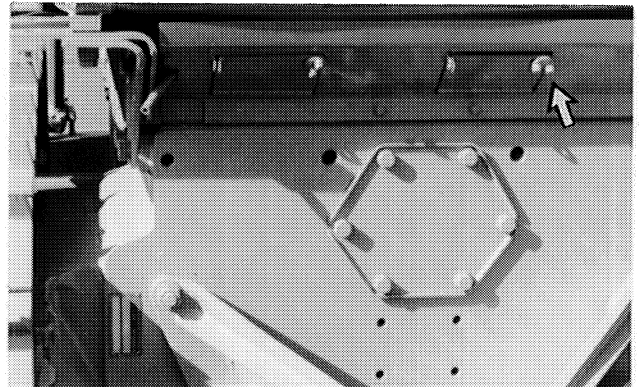

1. Open the fuel shutoff access door.

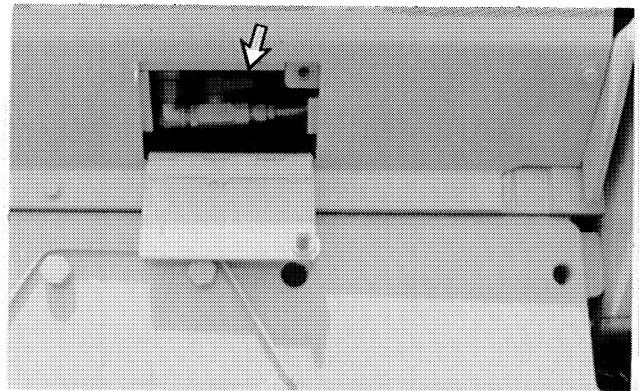

2. Turn the red handle on the fuel supply valve to the right (clockwise) to shut off the fuel supply.

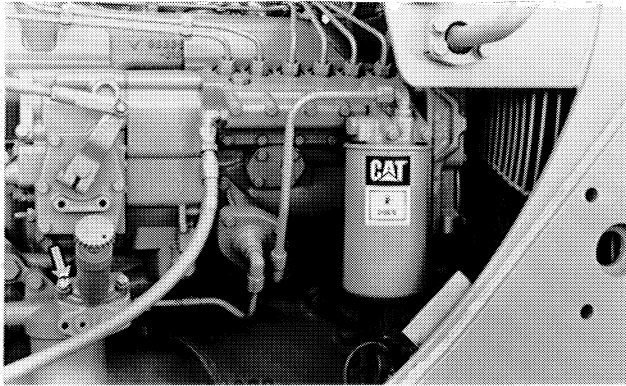

3. Loosen the filter housing retaining bolt, remove the housing and element.
4. Remove the element from the case, and wash the element and housing in clean, nonflammable solvent.
5. Dry the element using pressure air, and install the element and case into housing.
6. Retighten the retaining bolt to a torque of  $24 \pm 4$  N•m ( $18 \pm 3$  lb ft).

### Change Secondary Filter

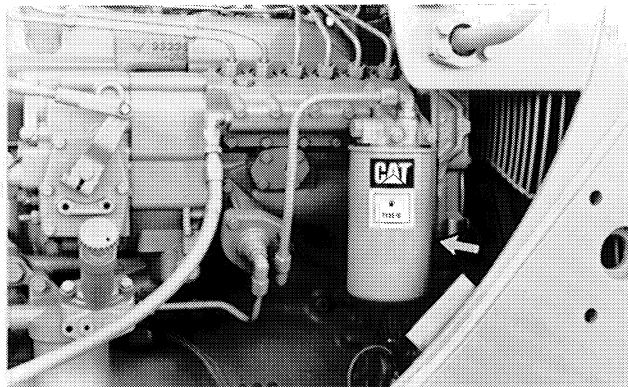

1. Remove and properly discard the filter.
2. Clean the filter mounting base. Be sure all of the old seal is removed. Coat the seal of the new filter with clean diesel fuel.
3. Install the new filter by hand. When the seal contacts the base, tighten  $\frac{3}{4}$  turn more.
4. Open the fuel supply valve.
5. Prime the fuel system. (See next topic).

### Fuel Priming Pump

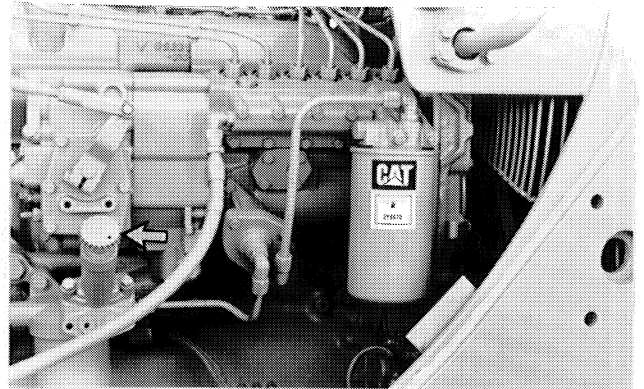

1. Turn the priming pump plunger to the left (counterclockwise) to unlock.
2. Operate pump until a slight pressure is felt.
3. Turn the plunger to the right (clockwise) to lock.
4. Start the engine and inspect for leaks.

## Flywheel Clutch and Brake

### Clutch Adjustment

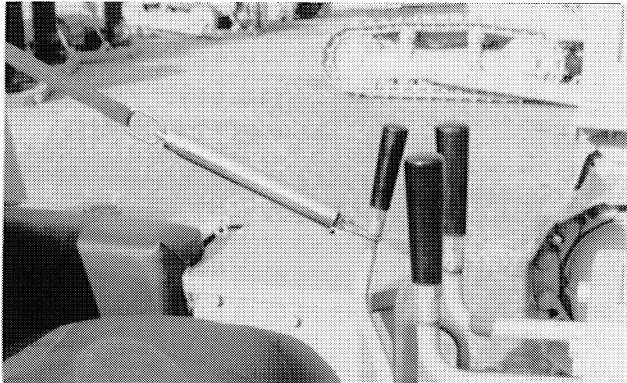

---

#### NOTICE

Measure clutch pull and make adjustment with the engine stopped and the clutch cold.

---

1. Attach a spring scale to the clutch lever and pull back to measure.

A properly adjusted clutch requires a pull of  $200 \pm 22$  N ( $45 \pm 5$  lb).

Slightly more effort may be required if the clutch is warm.

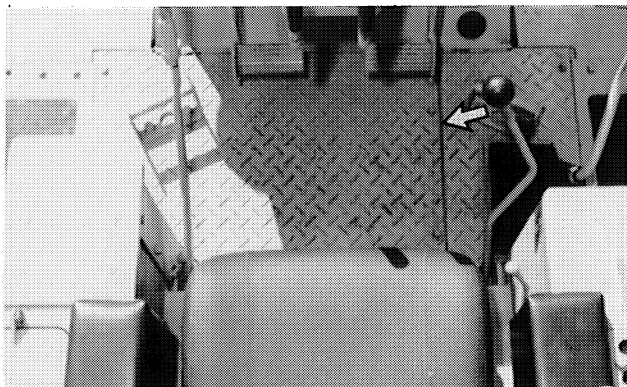

2. Remove the floor plate to adjust.

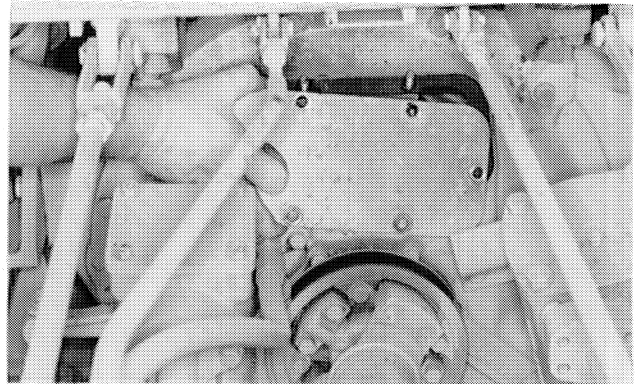

3. Remove the clutch inspection cover.

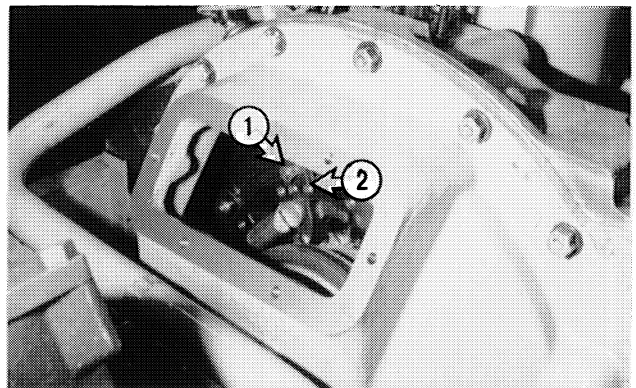

4. Turn flywheel until locknut (1) is visible.
5. Loosen locknut two turns.
6. Tap retainer plate (2) to be sure it is loose on the stud.
7. Turn the flywheel 180 degrees and loosen the other locknut.
8. Turn the adjusting ring to the right to increase or left to decrease, to obtain the correct force needed to engage the clutch.
9. Tighten both locknuts to a torque of  $40 \text{ N}\cdot\text{m}$  (30 lb ft).
10. Install the inspection cover and the floor plate.

## Clutch Brake Adjustment

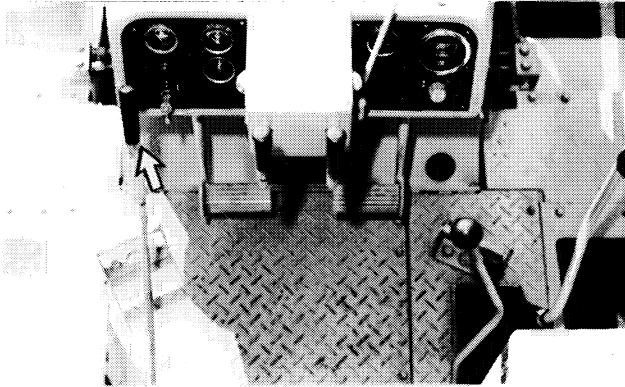

### NOTICE

Grinding of the gears during shifting may indicate the need to check for proper adjustment.

Do not adjust the brake too tight. Difficult shifting and rapid brake lining wear could result.

1. Remove the floor plate to observe the clutch brake movement.
2. Push the clutch brake lever forward with the engine running.
3. Adjust the brake if the clutch shaft is slow in stopping.
4. Stop the engine.

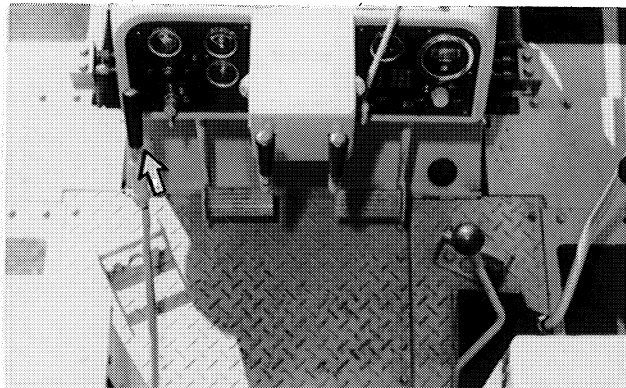

5. Push the lever forward to engage the clutch brake.

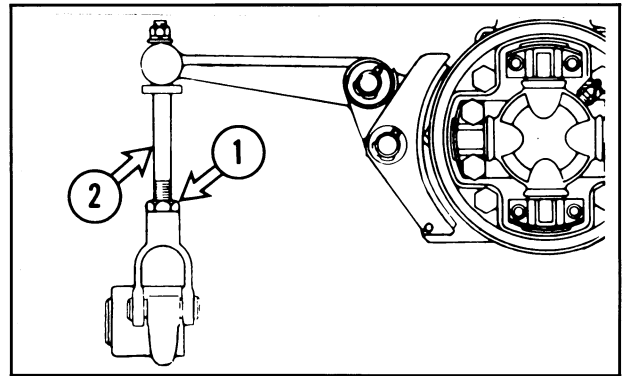

6. Loosen locknut (1).
7. Turn rod (2) until the brake lining comes in contact with the brake drum.
8. Pull the lever back to disengage the flywheel brake.
9. Turn rod (2) to the right (clockwise) two revolutions.
10. Tighten locknut (1).
11. Install the floor plate.
12. Start the engine and retest the clutch brake.

## Windshield Wiper/Washer (If Equipped)

### Inspect Wiper Blades

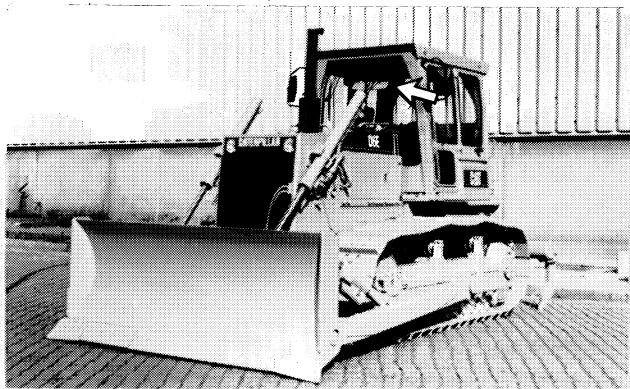

Inspect the windshield wiper blades. Replace if any are worn or damaged, or if streaking occurs.

### Fill Washer Reservoir

---

#### NOTICE

When operating in freezing temperatures, use Caterpillar nonfreezing window washer solvent or equivalent. System damage can result from freezing.

---

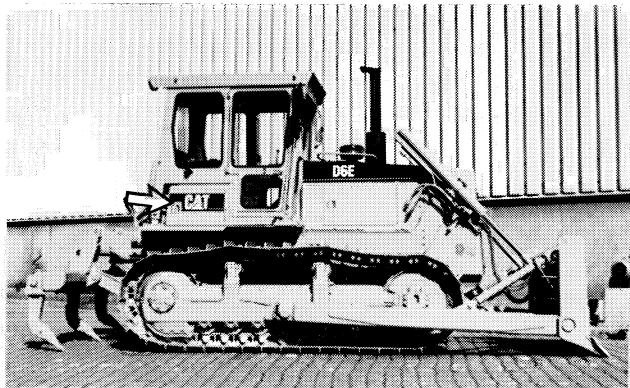

Fill the reservoir, located on the right side of the operator's compartment, with solvent. Close the access cover.

## Every 10 Service Hours or Daily

*You must read and understand the warnings and instructions contained in the Safety section of this manual, before performing any operation or maintenance procedures.*

### Walk-Around Inspection

#### Inspect Machine

---

##### NOTICE

Accumulated grease and oil on a machine is a fire hazard. Remove this debris with steam cleaning or high pressure water, at least every 1000 hours or each time any significant quantity of oil is spilled on a machine.

---

**NOTE:** Keep a close watch for leaks. If leaking is observed, find the source and correct the leak. Check the fluid levels more frequently than the recommended periods if leaking is suspected or observed.

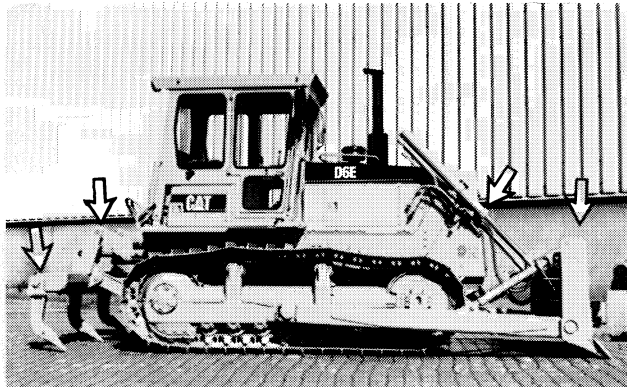

- Inspect all attachments for damage or excessive wear. Repair if damaged.
- Inspect attachment cylinders and linkage for damage or excessive wear. Repair if damaged.
- Inspect the lights for broken bulbs and lenses. Replace if broken.

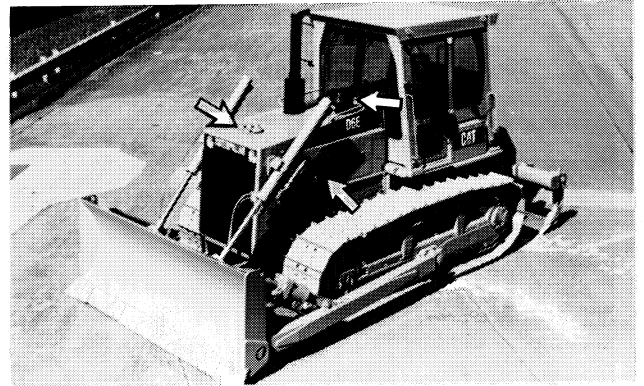

- Inspect and remove any trash build up in the engine compartment.
- Inspect the cooling system for leaks, faulty hoses and trash build up. Correct any leaks and remove any trash from the radiator.
- Inspect the engine precleaner screen for dirt build-up. Remove any dirt or debris.

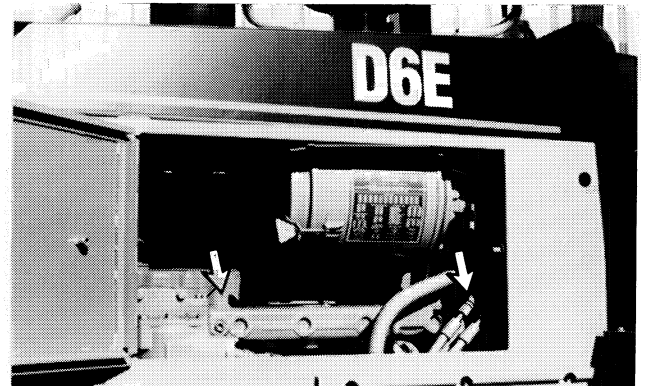

- Inspect and repair any engine compartment leaks. Check around all seals and covers.
- Inspect the steps and handholds for their condition and cleanliness. Inspect the Rollover Protective Structure (ROPS), and the Falling Object Protective Structure (FOPS) for damage. If repair is necessary contact your Caterpillar dealer. Tighten any loose ROPS or FOPS bolts.

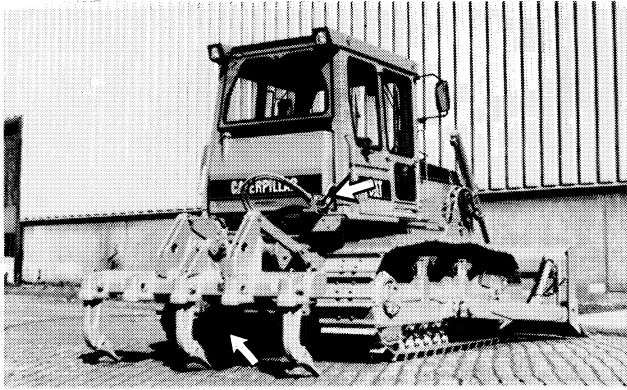

- Inspect and repair any hydraulic system leaks. Inspect hoses, seals and around flanges.
- Inspect the differentials and final drives under the machine for leaks.

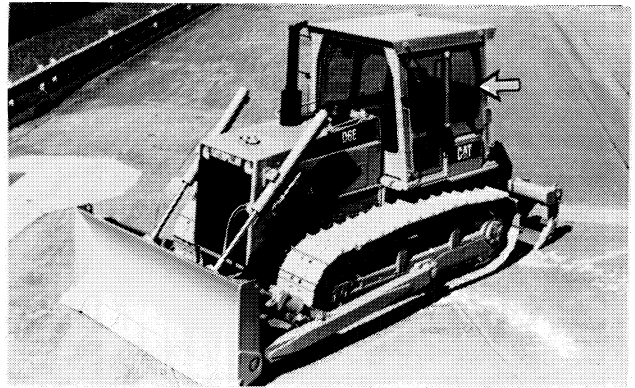

- Inspect operator's compartment for cleanliness and remove all trash and dirt build-up.

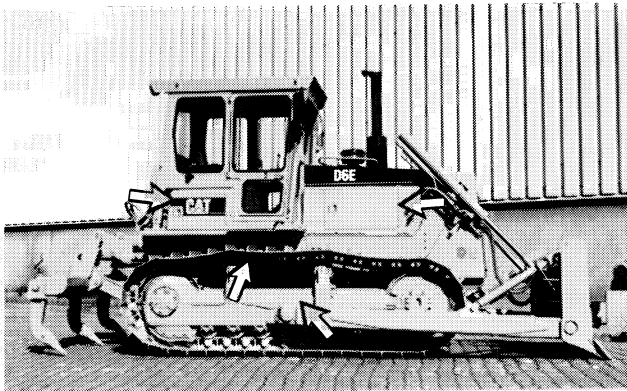

- Be sure covers and guards are firmly in place. Inspect for damage or for loose and missing bolts.
- Inspect transmission for leaks.
- Inspect and repair damaged and excessively worn tracks. Tighten any loose bolts and replace any that are missing.

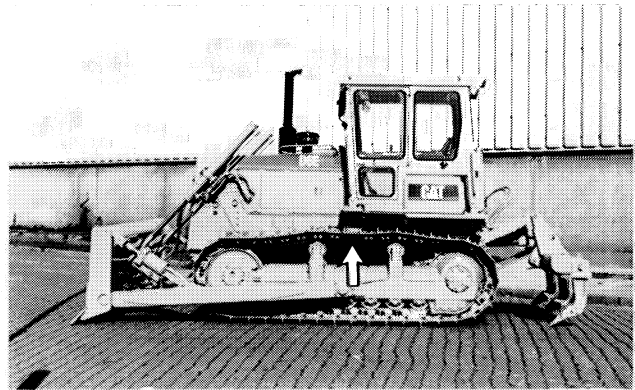

- Visually inspect the tracks. Check for wear and excessive dirt build-up on track components.
- If track appears to be too tight or too loose, see the topic Tracks under Every 250 Service Hours or Monthly in the Maintenance Section of this manual.
- Make sure the horn, back-up alarm, lights, guards, shield, etc., are in proper working order.

## Seat Belt

### Inspect for Wear or Damage



Seat belt and mounting hardware must be inspected for wear or damage before operating the machine. Replace the belt or mounting hardware if worn or damaged.

Replace the seat belt after three years of usage, regardless of appearance.

## Window Cleaning

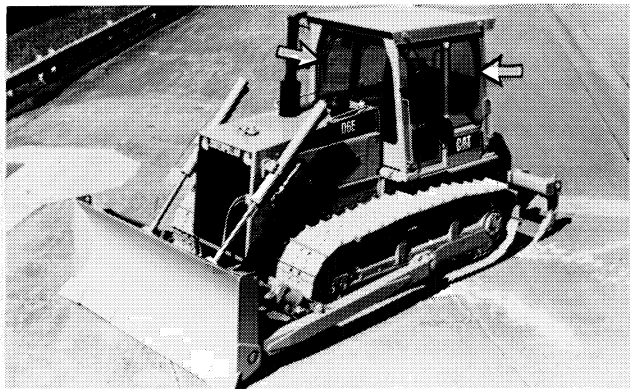

Use commercially available window cleaning solutions to clean the windows. Clean the outside windows from the ground, unless handrails are available.

Remove the rear window by lifting the latch and sliding the window to the full open position. Lift the window out of the track to remove.

## Engine Crankcase Oil

### Check

---

#### NOTICE

Do not overfill the crankcase. Engine damage can result.

---

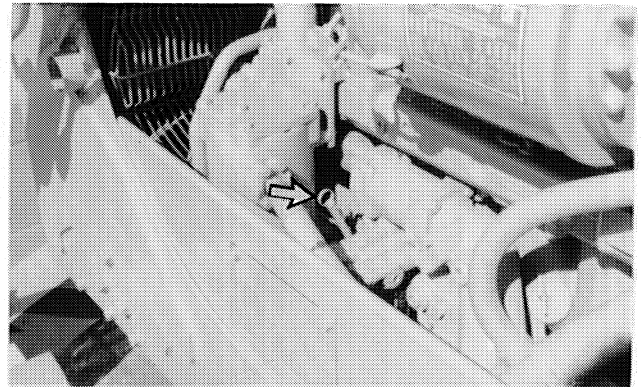

The crankcase oil level dipstick is located on the left side of the engine. The oil level can be measured on either side of the dipstick as shown below.

1. Open the access cover. Maintain the oil level between the ADD and FULL marks on the dipstick with the engine running.
2. Maintain the oil level between the marks on the engine stopped side of the dipstick with the engine stopped.
3. Remove the oil fill cap and add oil if necessary.
4. Clean and install the fill cap.
5. Close the access cover.

## Power Train Oil System

### Check

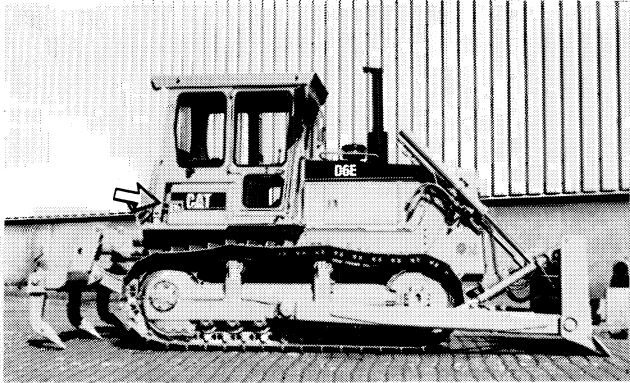

The power train oil dipstick is located on the right side of the machine.

1. Open the right side access door.

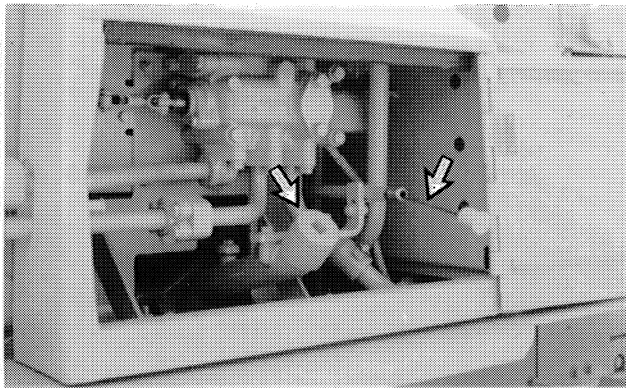

2. Measure the oil level, with the engine at LOW IDLE and at operating temperature. Maintain the oil level to the FULL mark on the dipstick.
3. Remove the oil filler cap if necessary to add oil.
4. Add oil as required to maintain the oil to the FULL mark on the dipstick.
5. Clean and install the cap.
6. Close the access door.

## Hydraulic Tank Oil

### Check

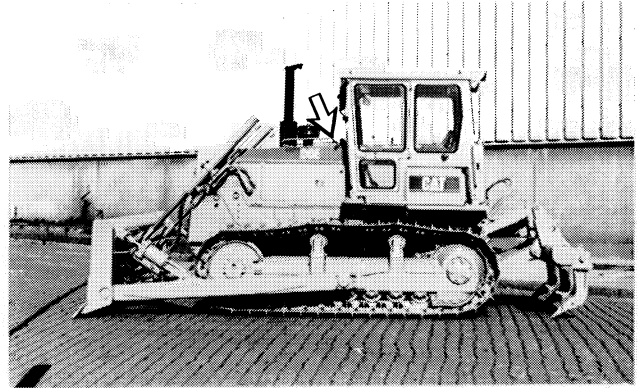

The hydraulic oil tank is located on the left side of the machine.

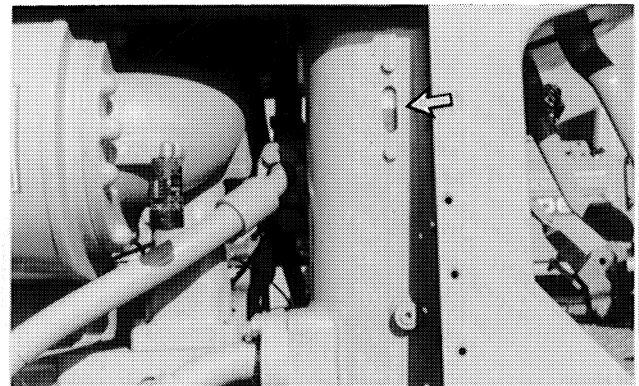

1. Maintain the oil level to the FULL mark on the sight gauge.

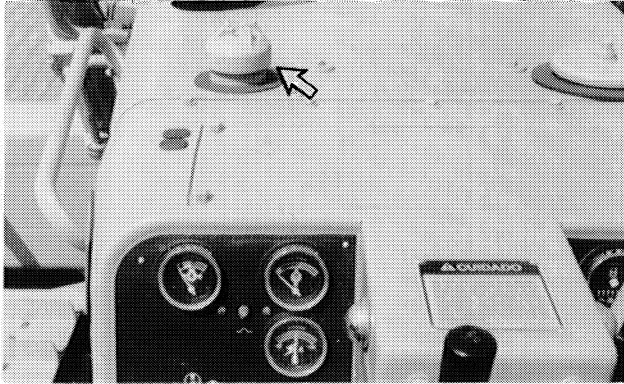

2. Remove the oil fill cap and add oil, if necessary, through the fill tube.
3. Clean and install the fill cap.

## Radiator

### Check Coolant Level

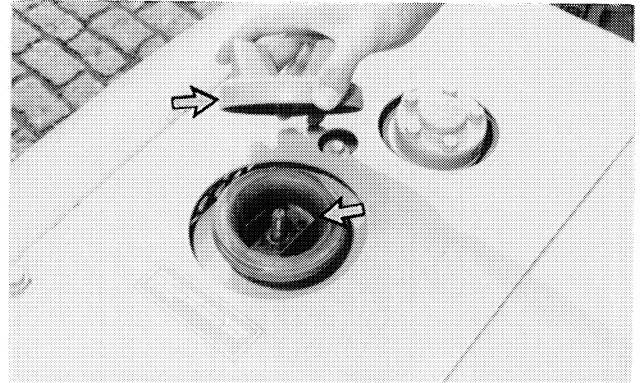

1. Remove the radiator cap slowly to relieve pressure.
2. Maintain the coolant level to within 13 mm (.50 in) of the bottom of the fill pipe. If it is necessary to add coolant daily, check for leaks.
3. Inspect the cap and cap seal for damage, deposits or foreign material. Clean the cap with a clean cloth or replace the cap if it is damaged.
4. Install the cap.
5. Inspect the radiator core for debris and clean if necessary.

Compressed air is preferred, but high pressure water or steam can be used to remove dust, leaves and general debris from a radiator. Clean as required by condition of radiator.

## Fuel Tank

### Drain Moisture and Sediment

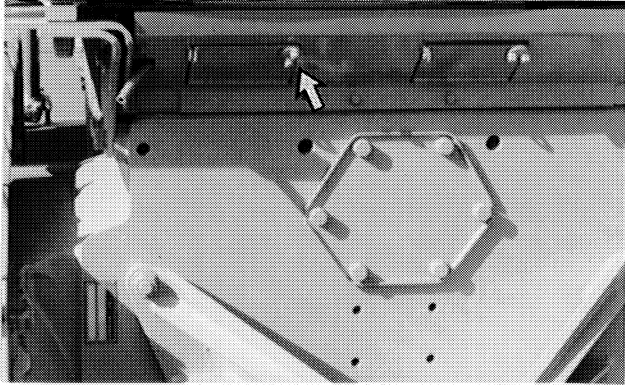

1. Open the fuel drain valve access cover. The access cover is located at the rear of the machine.

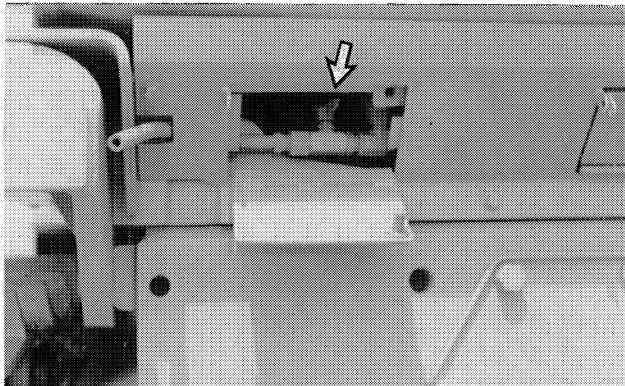

2. Open the drain valve and allow the moisture and sediment to drain.
3. Close the drain valve.
4. Close the access cover.

## Indicators and Gauges

### Test for Proper Function

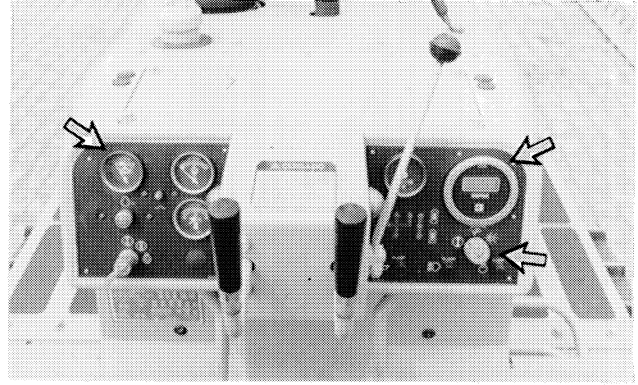

1. Look for broken gauge lenses or lights, switches, etc.
2. Start the engine.
3. Look for inoperative gauges.
4. Stop the engine.
5. Make needed repairs.

## Back-up Alarm (If Equipped)

### Test

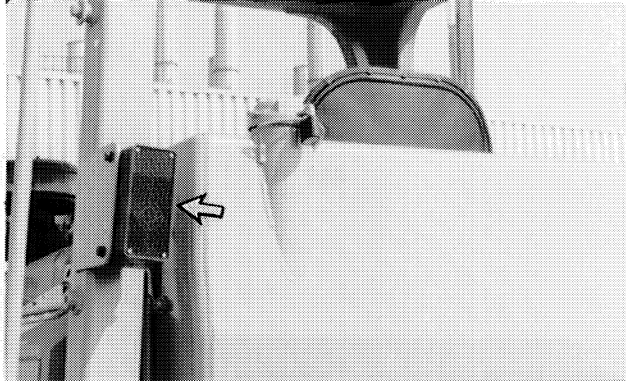

The back-up alarm is located on the rear of the machine.

Turn the start switch knob to ON to perform the test.

Apply the service brake. Move the transmission control lever into REVERSE.

The alarm should start to sound immediately. It should continue to sound until the transmission control lever is moved to NEUTRAL or FORWARD.

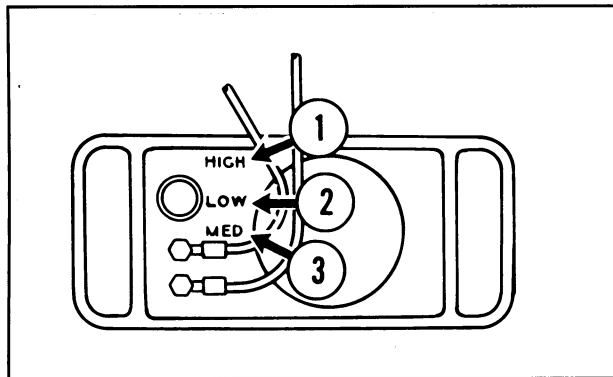

The sound level can be adjusted by moving the adjustment on back of alarm to meet operating requirements. The alarm is set at the highest sound level when shipped from the factory. The setting should remain on high, unless the job site requires a lower level.

## Every 50 Service Hours or Weekly

*You must read and understand the warnings and instructions contained in the Safety section of this manual, before performing any operation or maintenance procedures.*

### Batteries

#### Check Electrolyte Level

BATTERY ELECTROLYTE CHART	
Battery	Interval
Conventional	100 Hour
Low Maintenance	250 Hours
Maintenance Free	None Required

Tighten the battery retainers every 1000 service hours on all batteries.

Check the following at least every 1000 service hours, and more often, if conditions require:

- Clean the top of the battery with a clean cloth.
- Keep the terminals clean and coated with petroleum jelly.

At the proper charging rate in a moderate climate, a battery should not require more than 30 cc (1 oz) of water per cell per week. Check the cells weekly in extreme temperatures, cell water usage could be higher.

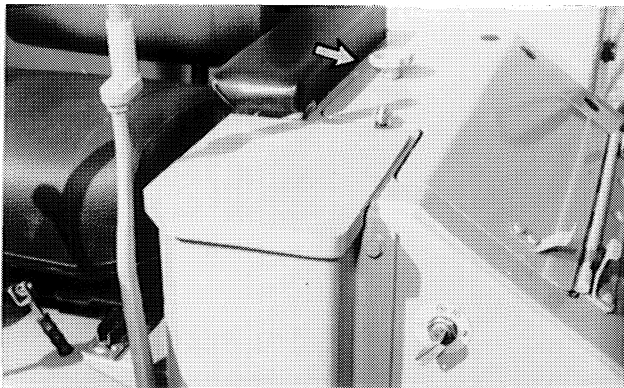

1. Unlatch and raise the left side battery compartment cover.

Remove the insert over the battery.

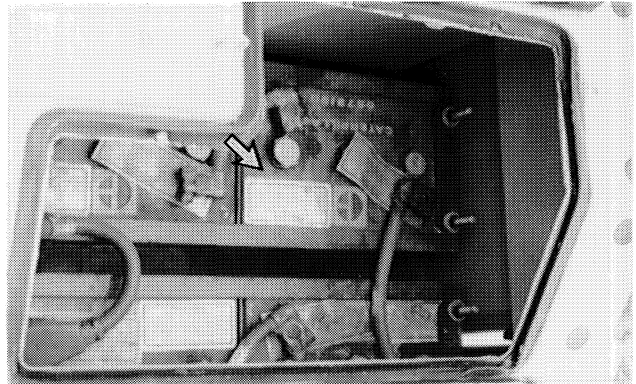

2. Clean the tops of the batteries with a clean cloth. Check the cable clamps and terminals for corrosion or looseness. If necessary, clean, tighten or replace the cable clamps.

3. Clean the cable clamps and the terminals with a wire brush. Coat the terminals with petroleum jelly.

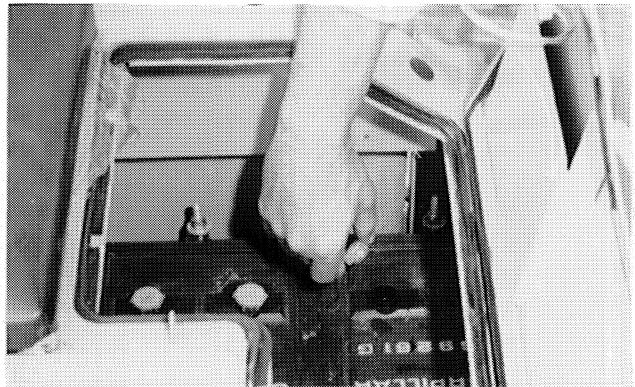

4. Remove the filler caps. Bring the electrolyte level to the bottom of the filler plug openings. Install the plugs.

If an addition of water is necessary, use distilled water. If distilled water is not available, use clean water that is low in minerals. Do not use artificially softened water.

## Ripper Linkage and Cylinder Bearings (If Equipped)

Lubricate

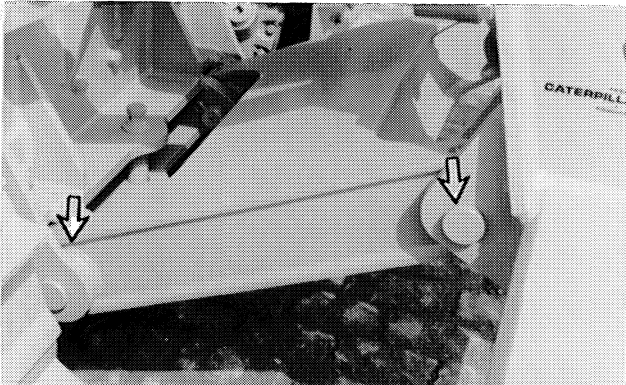
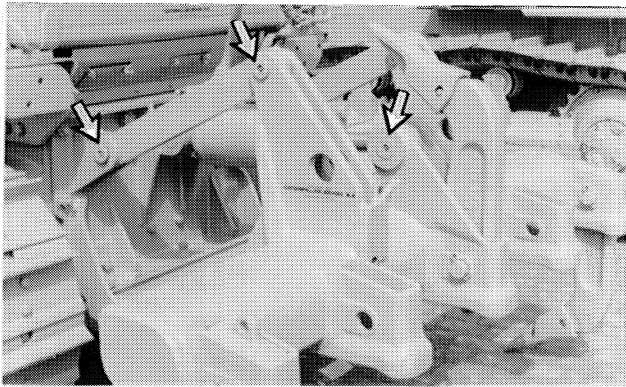

Lubricate 10 fittings.

## Cab Air System (If Equipped)

Clean Filter Elements

### **WARNING**

Pressure air can cause personal injury.

When using pressure air for cleaning, wear a protective face shield, protective clothing and protective shoes.

Clean the filter elements daily in dusty conditions and when there is a reduction of air circulation.

### Recirculation Filter Element

1. The recirculation filter element is located in the cab ceiling.

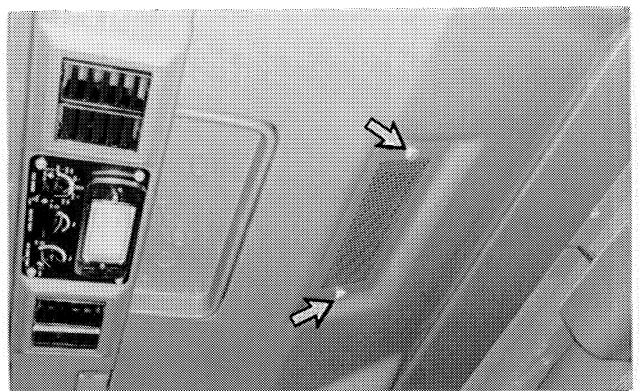

2. Loosen the two retainer screws and remove the cover.

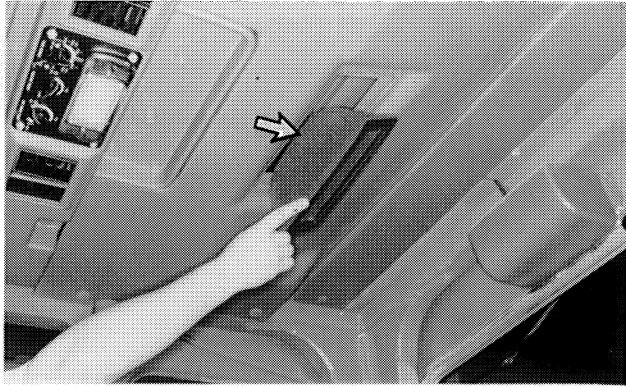

3. Remove the recirculation filter element.
4. Wash it in clean water and household detergent.
5. Rinse thoroughly with clear water and blow dry with pressure air.
6. Install the cleaned filter element.
7. Replace the cover and tighten the bolts.

### Fresh Air Filter Elements

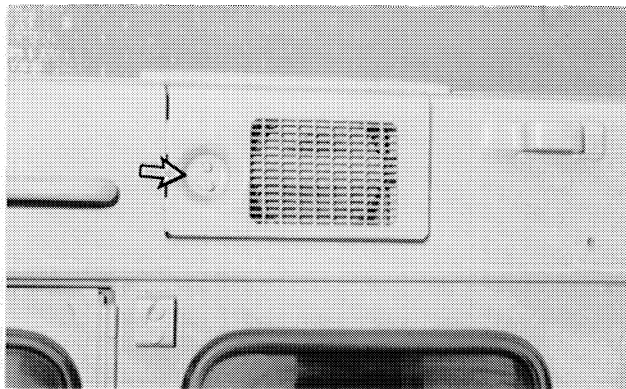

1. Loosen the screw on the filter element access covers on both sides of machine.
2. Open the covers.

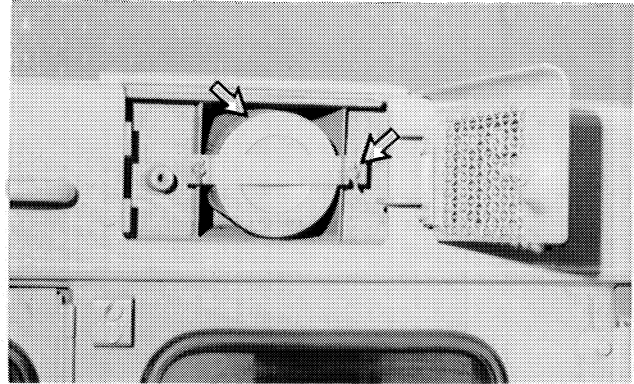

3. Loosen the wing nuts.
4. Remove and clean the filter elements. See the topic Cleaning Fresh Air Filter Elements under every 50 Service Hours in the Maintenance Section of this manual.
5. Clean the filter housing thoroughly.
6. Install the filter elements.
7. Tighten the wing nuts.
8. Close and secure the access covers.

### Cleaning Fresh Air Filter Elements

Elements can be cleaned with pressure air or pressure water.

---

#### NOTICE

Do not clean the elements by bumping or tapping them.

Inspect the elements after cleaning. Do not use an element with damaged pleats, gaskets or seals.

When cleaning with pressure air, use 205 kPa (30 psi) maximum to prevent element damage.

When cleaning with pressure water, use 280 kPa (40 psi) maximum pressure to prevent element damage.

---

### Pressure Air – 205 kPa (30 psi) Maximum

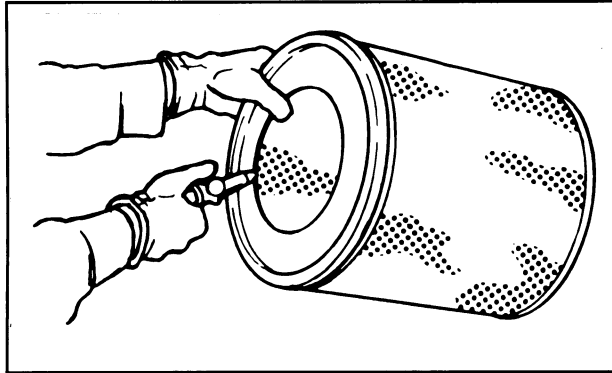

1. Direct air along the pleats inside and outside of the element.
2. Inspect the element after cleaning to see if any debris remains visible.

### Pressure Water – 280 kPa (40 psi) Maximum

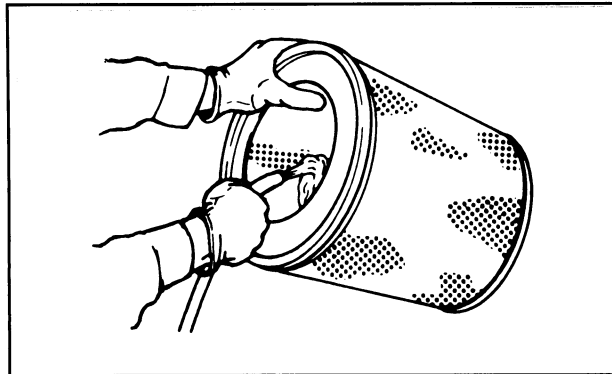

1. Direct water along the pleats inside and outside of the element.
2. Air dry and inspect the element to see if any debris remains visible.

## Bulldozer Cylinder Support Bearings

### Lubricate

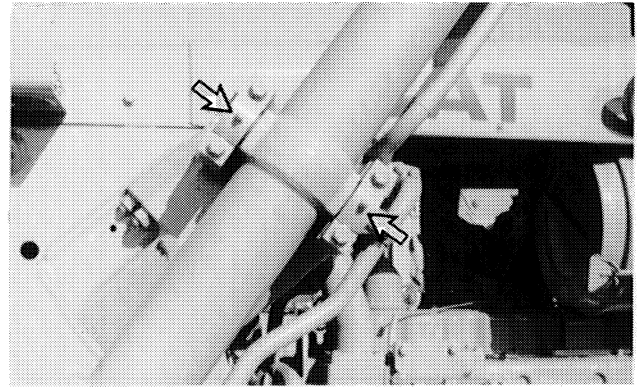

1. Lubricate the three fittings on the left side of the machine.
2. Lubricate the three fittings on the right side of the machine.

## Track Roller Frame Bearings

Lubricate



**1.** Lubricate the two inner bearing fittings, one on each roller frame.

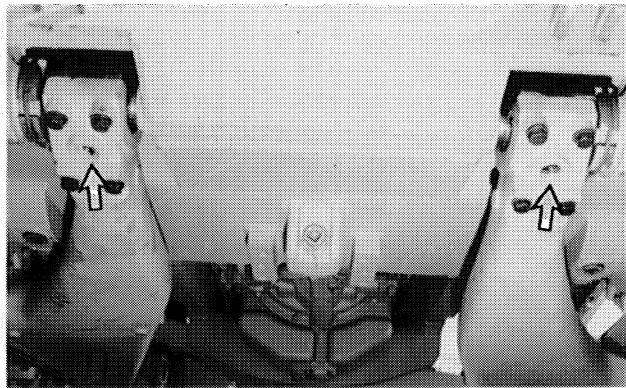

**2.** Lubricate the two outer bearing fittings, one on each side of the machine.

## Power Train Oil System

Change Filter Element – Clean Strainer

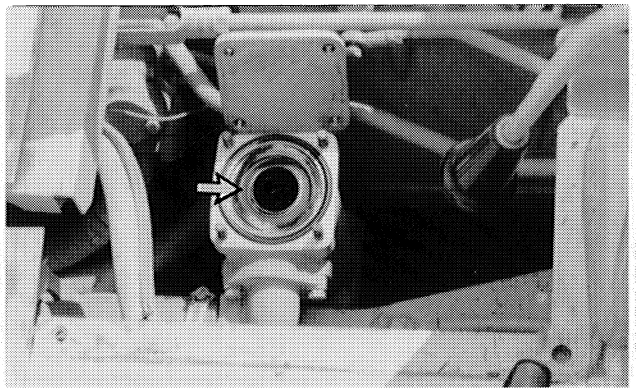

Change the filter element and wash the magnetic strainer on new or reconditioned power shift transmissions only.

See the topic Power Train Oil System – Power Shift under Every 1000 Service Hours or 6 Months in the Maintenance Section of this manual.

## Track Pins

### Inspect

#### WARNING

**Fingers can be burned from hot pins and bushings. The pins and bushings in a dry joint can become very hot. It is possible to burn the fingers if there is more than brief contact with these components.**

---

Follow these hints to extend the undercarriage life and to avoid excessive downtime.

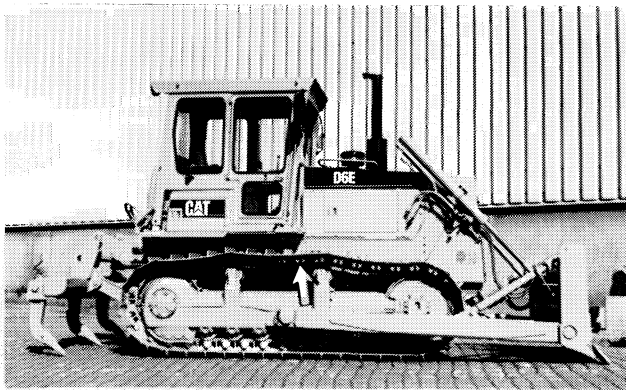

- 1.** Listen for track squeak or squeal during machine operation. This can indicate a dry joint.
- 2.** Check for dry joints once a week, immediately after machine operation. After machine operation, lightly touch the end of each track pin or bushing, with the back of your hand. Make a mark on any joint that is very hot to the touch.
- 3.** Do not hit the ends of the track pins with a sledge hammer to loosen the track joints.

---

#### NOTICE

Striking the end of a track pin introduces a significant amount of end play into the track joint and can result in early failures.

---

Contact your Caterpillar dealer's Custom track service expert upon detection of dry joints or leaks and/or for track inspection.

## Every 100 Service Hours or 2 Weeks

*You must read and understand the warnings and instructions contained in the Safety section of this manual, before performing any operation or maintenance procedures.*

### Hydraulic Control Linkage (If Equipped)

Lubricate

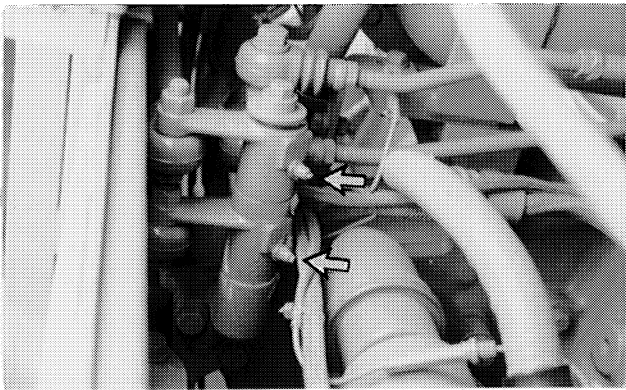

Located on the right side of the machine.

Lubricate two fittings.

### Sprocket Hub Bearings

Inspect

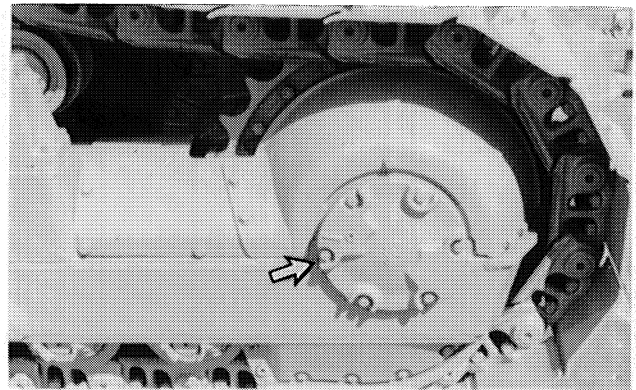
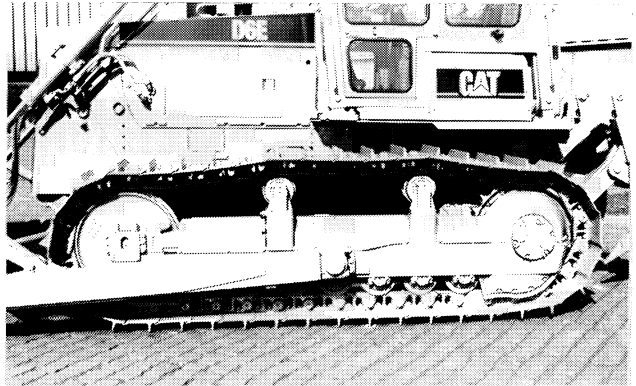

Inspect the sprocket hub bearing on new or reconditioned machines.

See the topic Sprocket Hub Bearings under Every 2000 Service Hours or 1 Year in the Maintenance Section of this manual.

## Every 250 Service Hours or Monthly

*You must read and understand the warnings and instructions contained in the Safety section of this manual, before performing any operation or maintenance procedures.*

### Engine Oil and Filter

#### Change

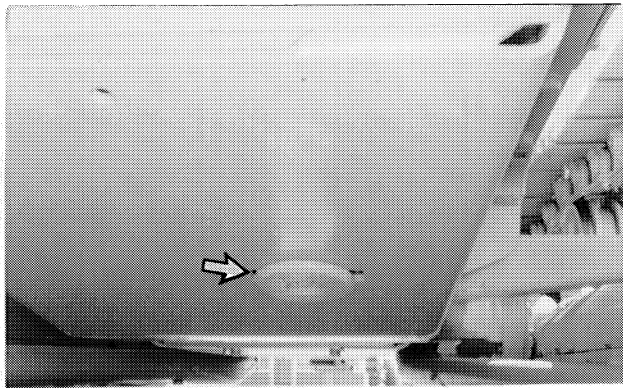

**1.** Remove the crankcase drain valve access cover located in the crankcase guard.

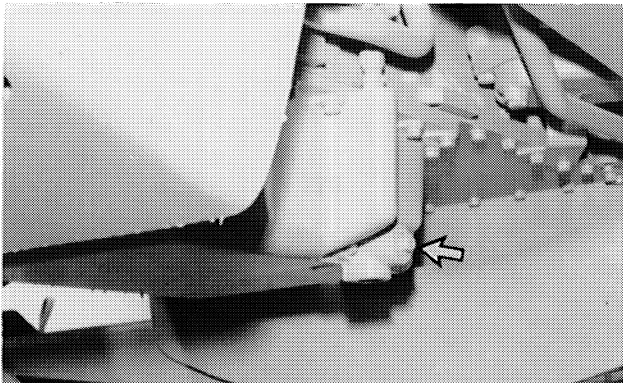

**2.** Open the drain valve. Allow the oil to drain into a suitable container.

**3.** Close the drain valve after all of the oil has drained.

**4.** Install the access cover.

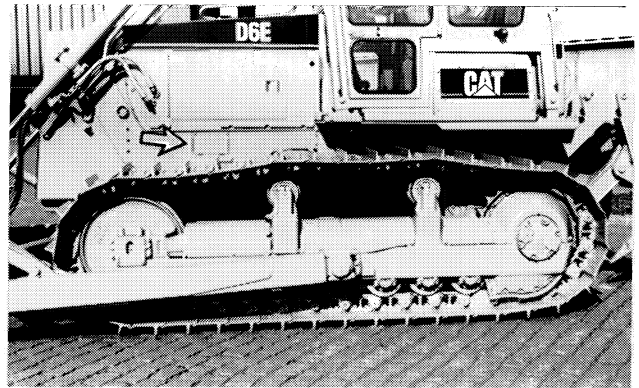

**5.** Remove filter element access cover.

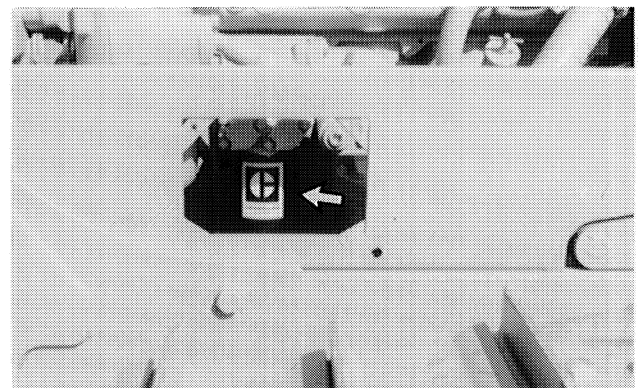

**6.** Remove and properly discard the used crankcase oil filter element. Make sure all of the old filter seal is removed from the filter base.

**7.** Apply a thin coat of oil to the seal on the new filter element.

**8.** Install the filter by hand until the filter contacts the base. Tighten  $\frac{3}{4}$  turn more.

There are rotation index marks on each new filter spaced 90 degrees apart, to be used as a guide for tightening.

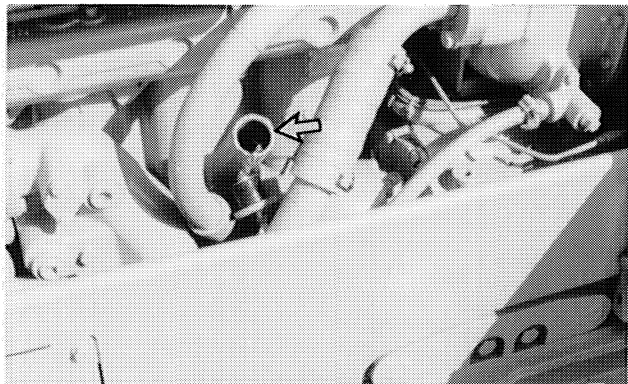

**9.** Remove the crankcase oil fill plug. Fill with oil. See the topic Refill Capacities in the Maintenance Section of this manual.

**10.** Always measure the oil with the dipstick to make certain the quantity of oil added is correct.

Maintain the oil level between the ADD and FULL marks.

**11.** Clean and install the fill plug.

**12.** Install the cover.

## Cooling System

### Add Supplemental Coolant Additive

See the topic Cooling System Specifications in the Maintenance Section of this manual for all cooling system requirements.

Use the 8T5296 Test Kit to check for concentration.

---

#### NOTICE

Excessive additive (greater than the recommended 6 percent initial fill) together with concentrations of anti-freeze greater than 60 percent cause deposits to form and can result in radiator tube blockage and overheating.

---

### Liquid Supplemental Coolant Additive

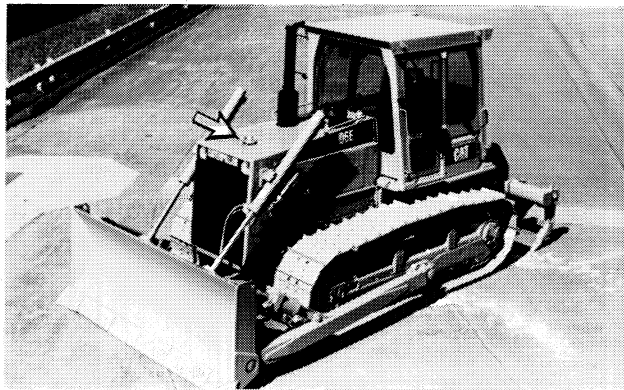

**1.** Loosen the fill cap slowly to relieve pressure and remove the cap.

**2.** It may be necessary to drain enough coolant from the radiator to allow for the addition of the liquid cooling system additive.

**3.** Add .24 liters (.50 pint) of additive for every 38 liters (10 U.S. gallons) of cooling system capacity.

**4.** Inspect the radiator cap gasket. Replace the cap if the gasket is damaged.

**5.** Start the engine and check for leaks. Allow the coolant level to stabilize.

**6.** Add premixed coolant if necessary to bring the coolant to within 13 mm (.50) below the bottom of the fill pipe.

## Fan Pulley Bearing

Lubricate

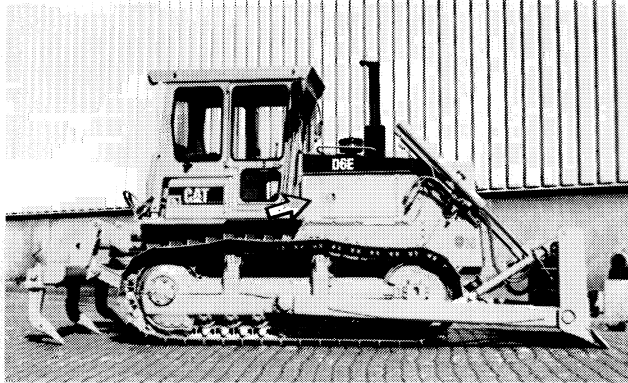

The fitting is located on the right side of the engine.

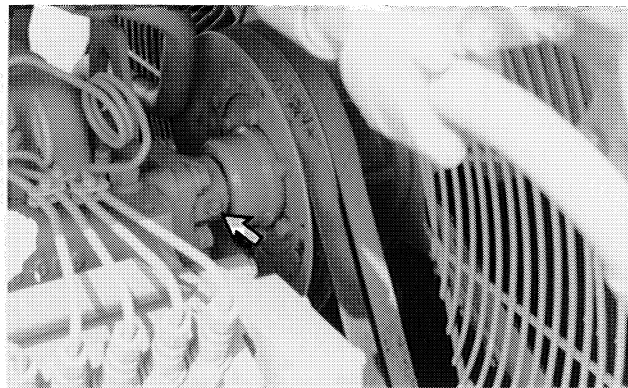

Lubricate fitting.

## Belts – Alternator, Fan and Air Conditioner

Inspect/Adjust Air Conditioner Belt  
(If Equipped)

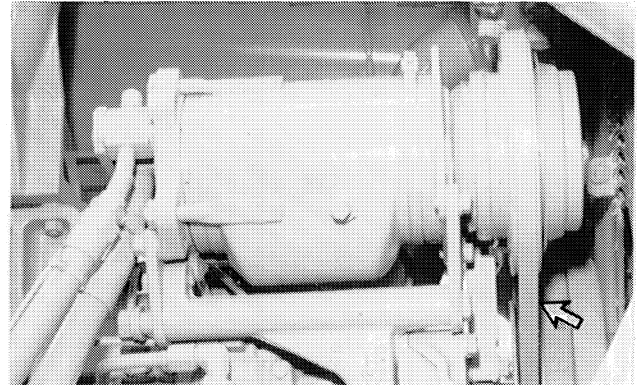

1. Replace the belt if cracked, frayed or cut.
2. Measure the deflection of the belt. Apply approximately 110 N (25 lb) force midway between the drive pulley and the air conditioning compressor pulley.

Deflection should be 14 to 20 mm (.56 to .81 in).

3. Adjust the belt if the deflection is not correct.

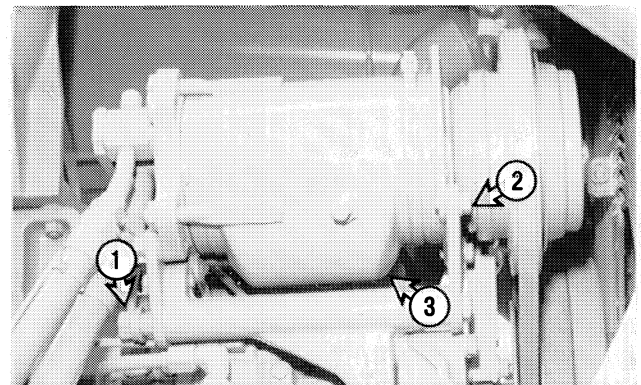

4. Loosen mounting bolt (1).
5. Loosen locknut (2).
6. Tighten adjusting nut (3), to move the compressor to obtain the required belt deflection.
7. Tighten the locknut and the mounting bolt.
8. Measure the belt deflection. If deflection is not correct, repeat the adjustment procedure.

### Adjust Alternator and Fan Belts

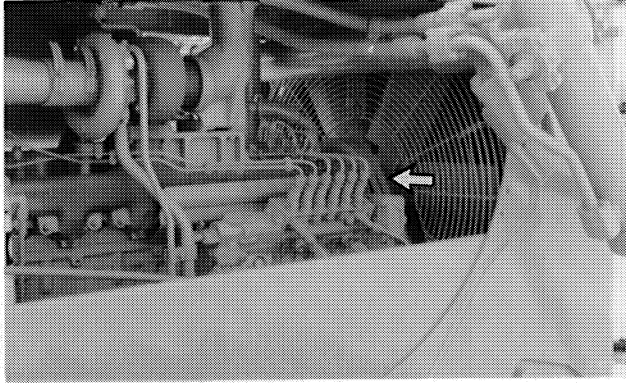

1. Replace the belts if cracked, frayed or cut.

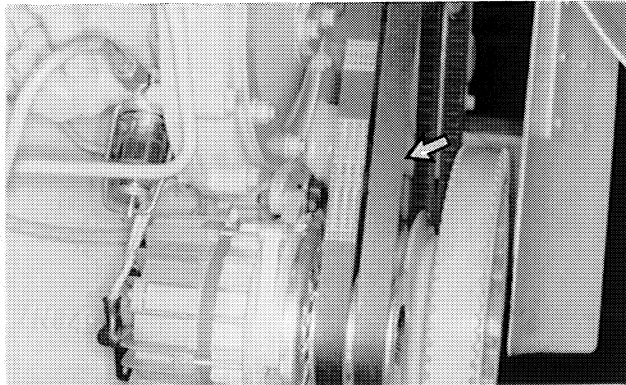

2. Measure the deflection of the belts. Apply approximately 110 N (25 lb) force midway between the drive pulley and the alternator.

Deflection should be 14 to 20 mm (.56 to .81 in).

3. Adjust the belts if the deflection is not correct.

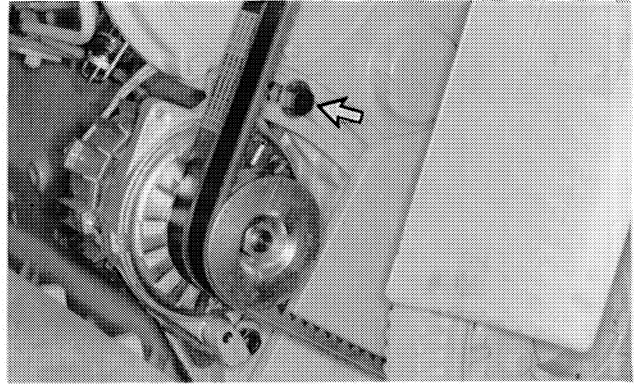

4. Loosen the mounting bolt and position mounting bolt.
5. Move the alternator to tighten the belts.
6. Tighten the bolts.
7. Measure the belt deflection. If deflection is not correct, repeat the adjustment procedure.
8. Replace the belts in sets, even if only one belt is damaged.

## Final Drives

### Check Oil Level

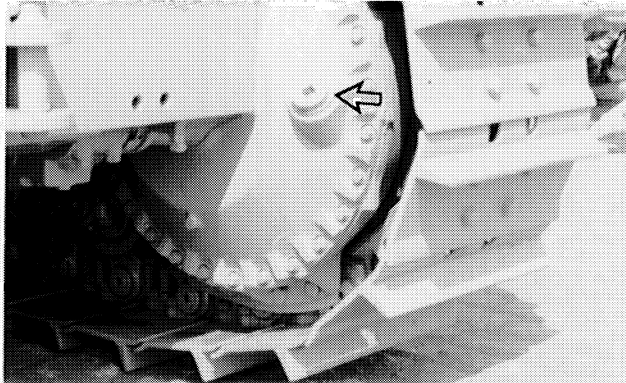

1. Remove the oil fill plug.

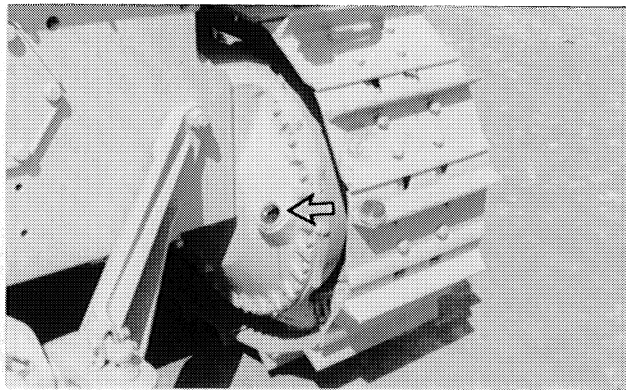

2. Look at the oil level. Oil should be to the bottom of the fill plug opening. Add oil if necessary.
3. Install the fill plug.
4. Perform Steps 1 through 3 on the other side.

## Power Train Oil System

### Change Filter Element

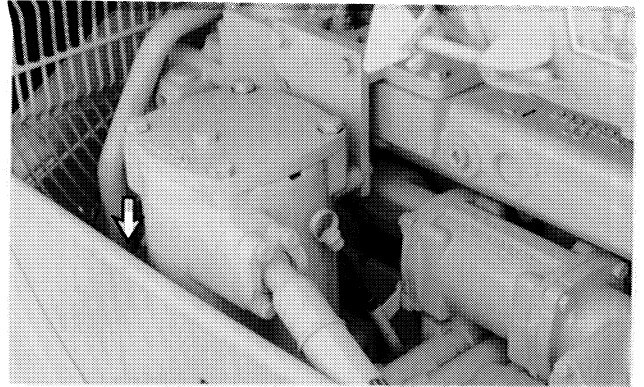

1. Remove the housing drain plug and allow the oil to drain into a suitable container.

2. Remove the cover.



3. Remove the used filter element from the housing.
4. Clean the inside of the housing with a clean cloth.
5. Clean the cover and replace the cover seal if damaged.
6. Install the new filter element.
7. Install the housing cover.
8. Clean and install the drain plug.

### Clean Screen and Magnets

1. Remove the floor plate.

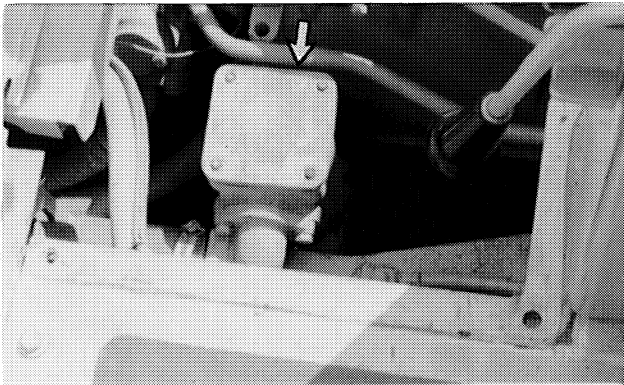

2. Remove the cover.

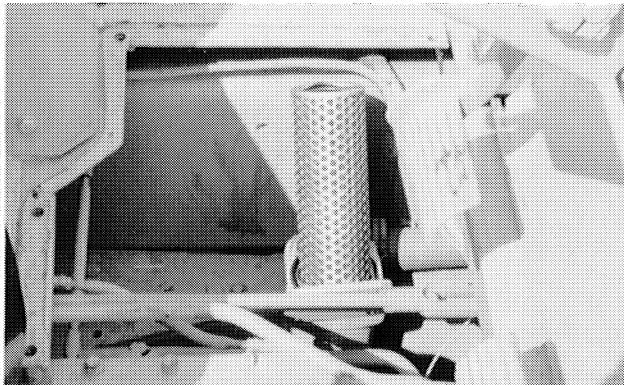

3. Remove the screen and magnets.

---

#### NOTICE

Do not drop or rap the magnets against anything. Replace any damaged magnets.

---

4. Wash the screen and magnets in clean, nonflammable solvent. Clean the magnets with a cloth, stiff brush or pressure air.

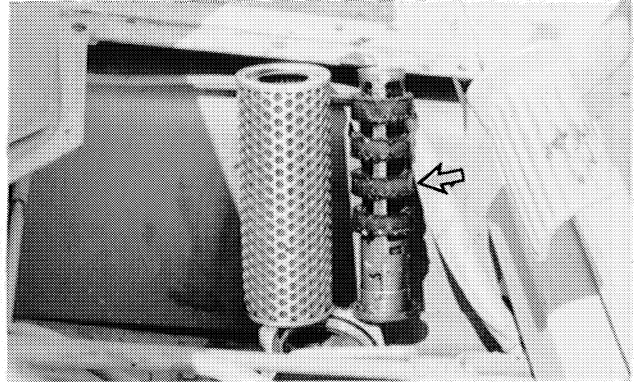

5. Install the magnets.
6. Install the screen.
7. Inspect the spring and seal. Replace them if damaged.
8. Install the cover and floor plate.
9. Start and run the engine at LOW IDLE.

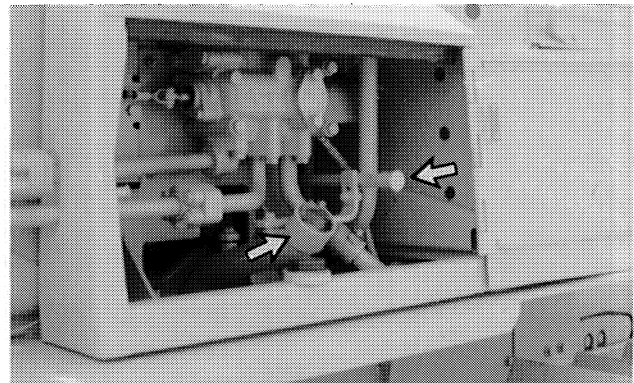

10. Maintain the oil level between the ADD and FULL marks on the dipstick.
11. Remove the oil filler cap to add oil if necessary.
12. Install the cap and close cover.

## Brakes

### Check Brake Pedals

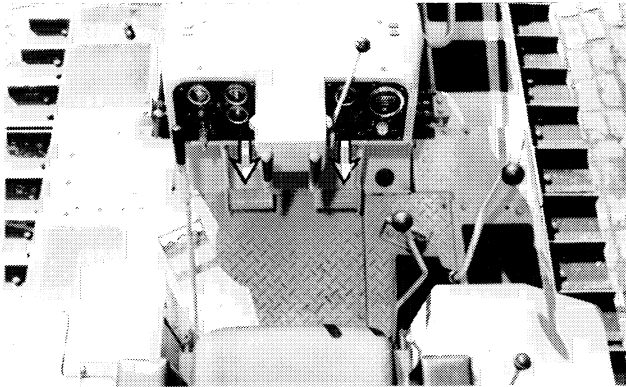

Adjust the brakes when the pedal travel measures 152 to 165 mm (6 to 6.5 in).

### To Adjust



1. Remove the guard.

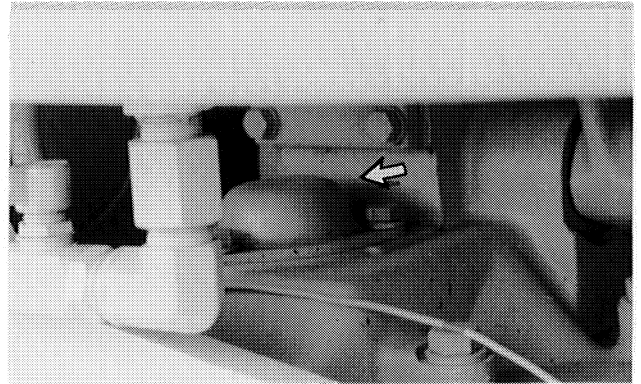

2. Remove the cover.
3. Turn the adjusting screw to the right until tight.
4. Turn the screw out 1 and ½ rotations (9 clicks of the detent noise).
5. Install the cover and guard.

### Check Parking Brake

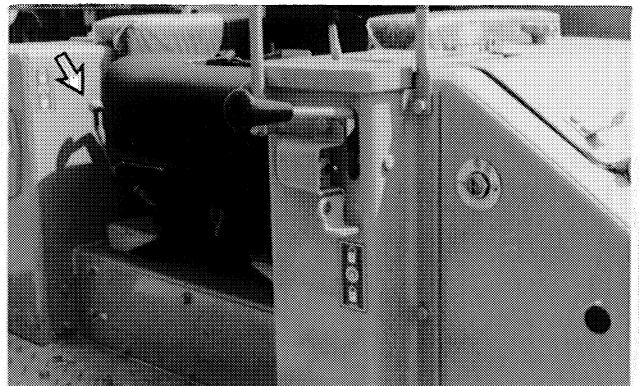

1. Adjust the parking brake linkage if the lever does not engage properly.

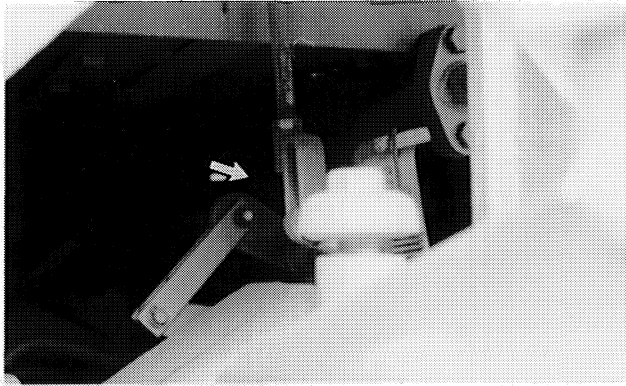

2. Disengage the parking brake lever and disconnect the lever to adjust.

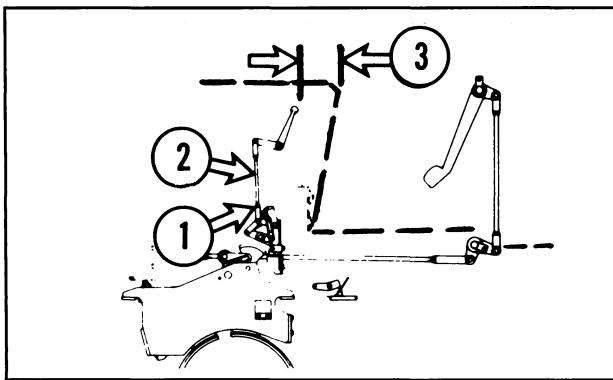

3. Loosen nut (1) and adjust the length of rod (2) so dimension (3) is  $102 \pm 3$  mm ( $4.02 \pm .12$  in).
4. Connect the linkage and check for proper parking brake lever engagement.

## Tracks

### Adjust

#### **WARNING**

**Grease is under high pressure.**

**Pressurized grease coming out of the relief valve can penetrate the body causing injury or death.**

**Do not watch the relief valve to see if grease is escaping. Watch the track or track adjustment cylinder to see if the track is being loosened.**

**Loosen the relief valve one turn only.**

Move the machine forward at least twice the length of the machine. Allow the machine to coast to a stop. Do not apply the brakes to stop the machine.



With the machine level, lower all attachments and apply with slight down pressure. Engage the parking brake lock lever, place the transmission in NEUTRAL and stop the engine.

Tracks should be adjusted under the same conditions in which the machine is used. If packing conditions prevail on the job, the tracks should be adjusted with packing present.

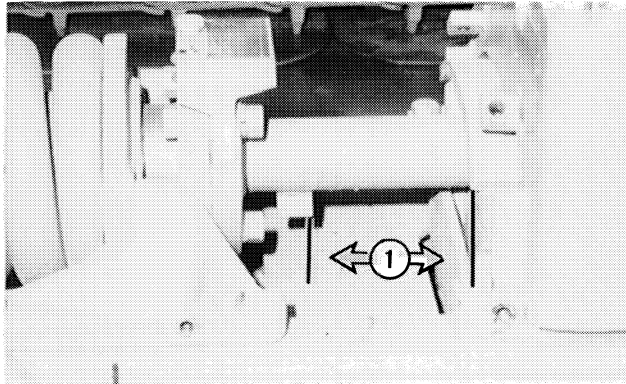

---

**NOTICE**

Do not attempt to tighten the track when dimension (1) is less than 3 mm (.12 in). Contact your Caterpillar dealer for track service or instructions.

---

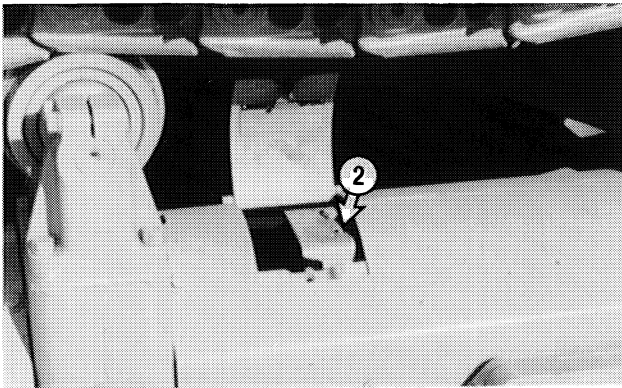

1. Remove adjusting valve cover plate.
2. Add grease (MPGM) through adjusting valve (2) until track is tight.

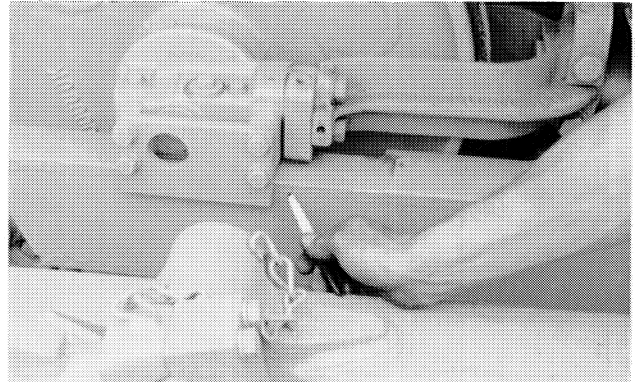

3. Make a mark on the roller frame 12 mm (.50 in) behind the idler bearing support. Be sure there is space for the front idler to retract.

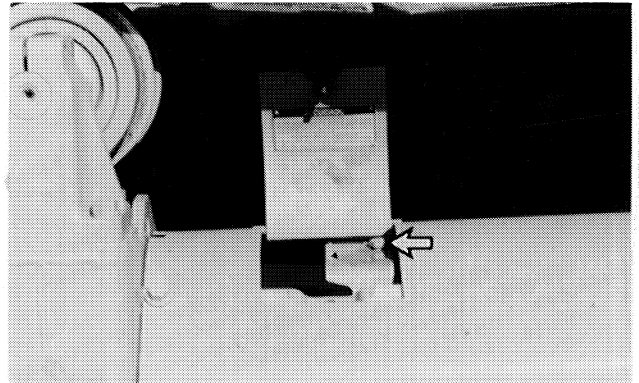

4. Allow the idler to move back by opening the relief valve ONE TURN ONLY. Moving the machine in REVERSE helps to move the idler back.
5. Close the relief valve.

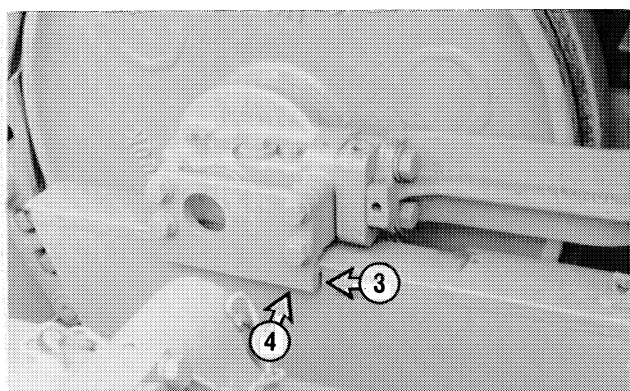
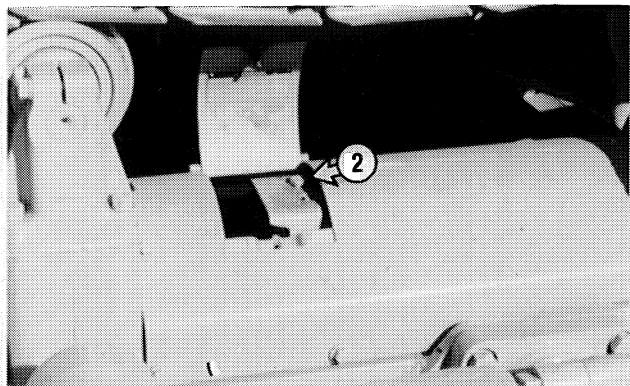

6. Add grease (MPGM) through adjusting valve (2) until the mark on roller frame (3) is aligned with the rear edge of idler bearing support (4).
7. Install the valve cover plate.
8. Repeat the procedure on the other track.

## Air Conditioner (If Equipped)

### Test

1. Start and run the engine at HIGH IDLE.

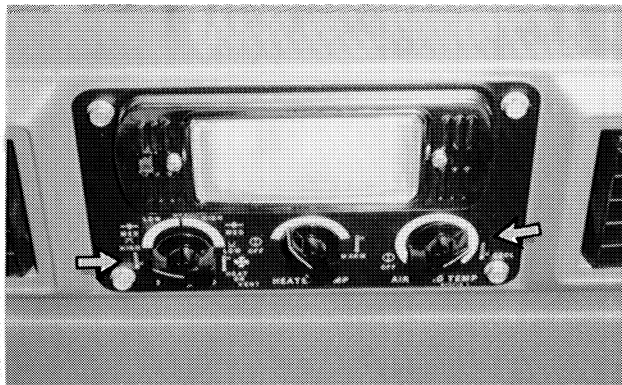

2. Set the air conditioner controls on MAXIMUM and the fan on HIGH.

Allow two minutes for the system to stabilize.

3. Turn the air conditioner off if poor cooling is experienced.
4. Stop the engine.
5. Inspect the cab air system for dirty filter elements.
6. See the topic Cab Air System under Every 50 Service Hours or Weekly in the Maintenance Section of this manual if filter elements are dirty.

If they are not dirty, have your Caterpillar dealer service the air conditioner system.

## Bulldozer Tilt Brace (If Equipped)

### Lubricate



Lubricate four fittings, two on each tilt brace.

## Every 500 Service Hours or 3 Months

*You must read and understand the warnings and instructions contained in the Safety section of this manual, before performing any operation or maintenance procedures.*

### Hydraulic System

#### Change Filter Element

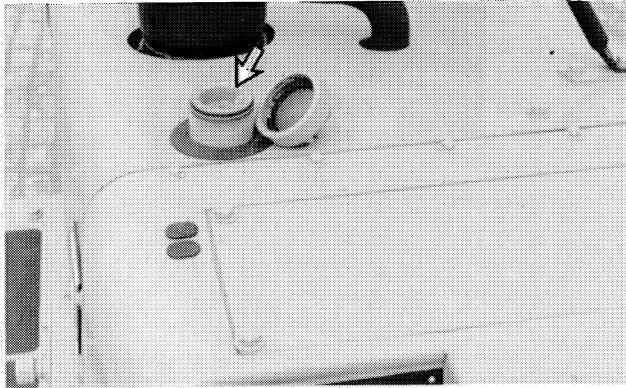

**1.** Remove the oil filler cap slowly to relieve the tank pressure.

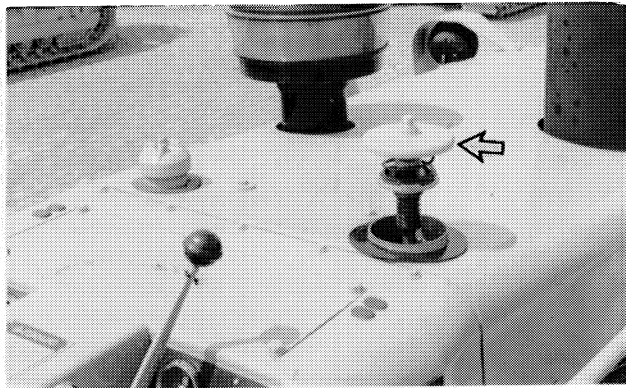

**2.** Loosen the retainer. Remove the cover and the filter element. Properly discard the filter element.

**3.** Inspect the condition of the O-ring seal in the cover. Replace the seal if it is worn or damaged.

**4.** Install the new filter element.

**5.** Clean and install the filter cover. Tighten the bolt to a torque of  $80 \pm 7 \text{ N}\cdot\text{m}$  ( $60 \pm 5 \text{ lb ft}$ ).

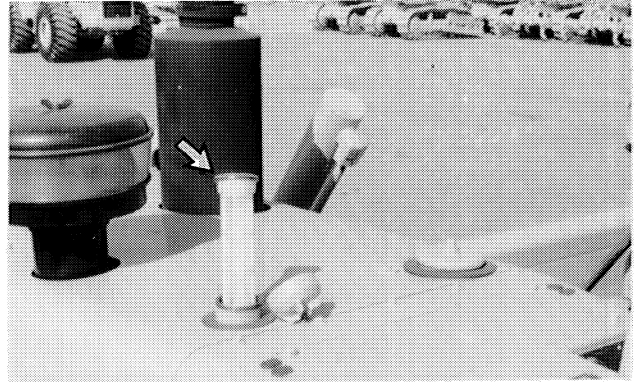

**6.** Remove the oil filler strainer. Clean the filler strainer and the oil filler cap in a clean nonflammable solvent. Install the strainer and cap.

**7.** Start and run the engine at LOW IDLE for a few minutes.

**8.** Stop the engine.

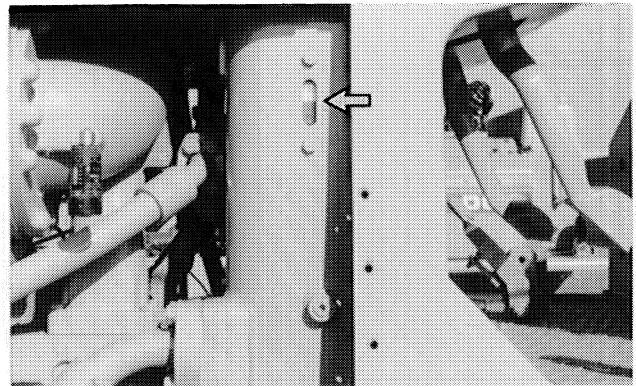

**9.** Maintain oil level to the FULL mark in sight gauge (3).

## Fuel System

### NOTICE

Do not fill fuel filters with fuel before installing them. Contaminated fuel causes accelerated wear to fuel system parts.

### Change Primary Filter



1. Open the fuel shutoff access door located at the rear of the machine.

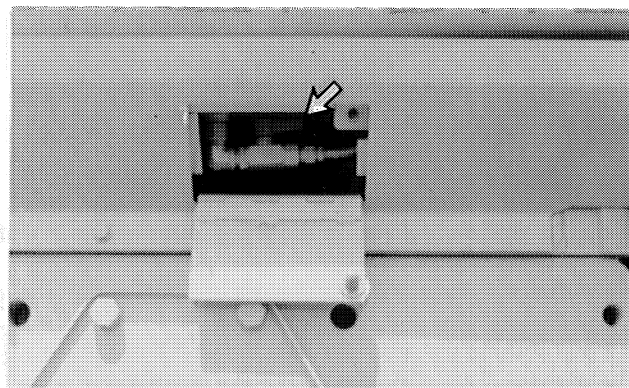

2. Turn the red handle on the fuel supply valve to the right (clockwise) to shut off the fuel supply.

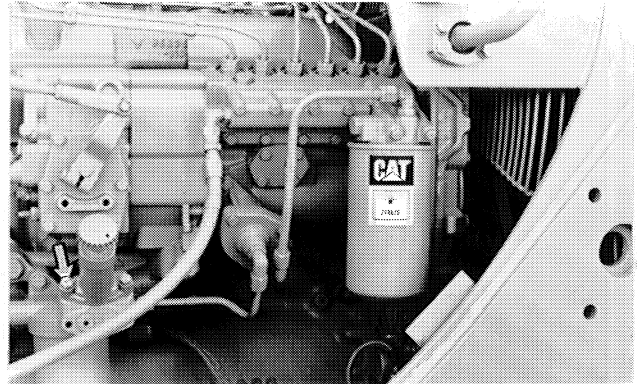

3. Loosen the filter housing retaining bolt, and remove the housing and element.
4. Remove the element from the case and wash the element and housing in clean, nonflammable solvent.
5. Dry the element using pressure air and install the element and case into housing.
6. Retighten the retaining bolt to a torque of  $24 \pm 4$  N•m ( $18 \pm 3$  lb ft).

### Change Secondary Filter

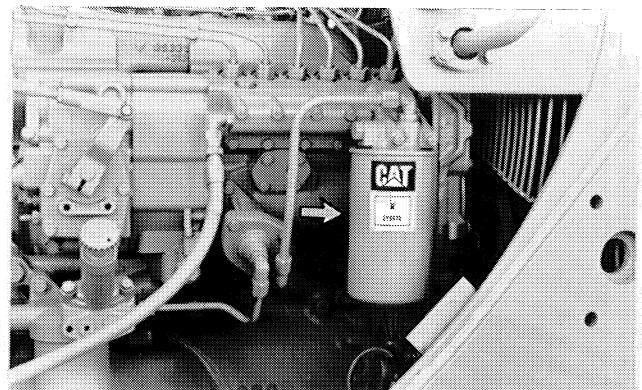

1. Remove and properly discard the filter.
2. Clean the filter mounting base. Be sure all of the old seal is removed. Coat the seal of the new filter with clean diesel fuel.
3. Install the new filter by hand. When the seal contacts the base, tighten  $\frac{3}{4}$  turn more.
4. Open the fuel supply valve.
5. Prime the fuel system. (See next topic).

## Priming Pump

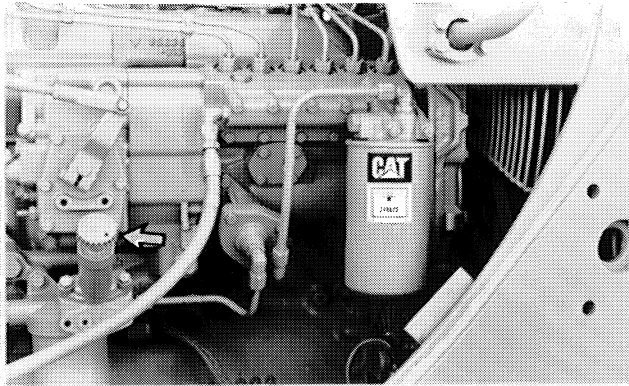

1. Turn the priming pump plunger to the left (counterclockwise) to unlock.

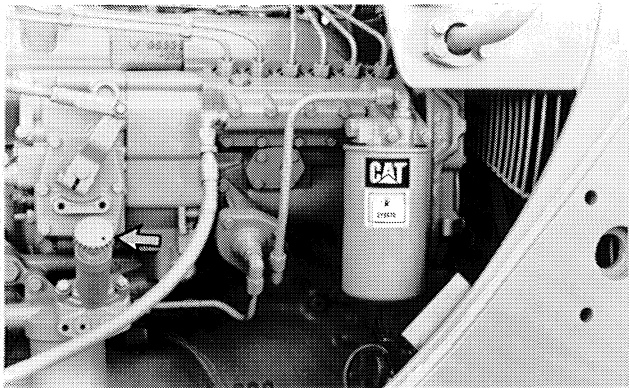

2. Operate pump until a slight pressure is felt.
3. Turn the plunger to the right (clockwise) to lock.
4. Start the engine and inspect for leaks.

## Fuel Tank

### Clean Cap and Fill Screen

1. Open the fuel tank drain valve access cover located at the rear of the machine.

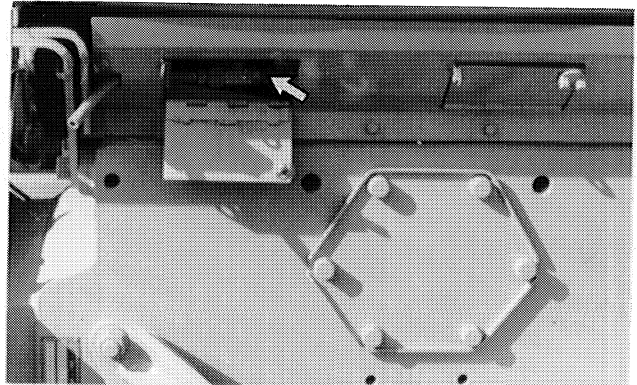

2. Open the fuel tank drain valve. Allow the sediment and water to drain into a suitable container.
3. Close the drain valve and the access cover.

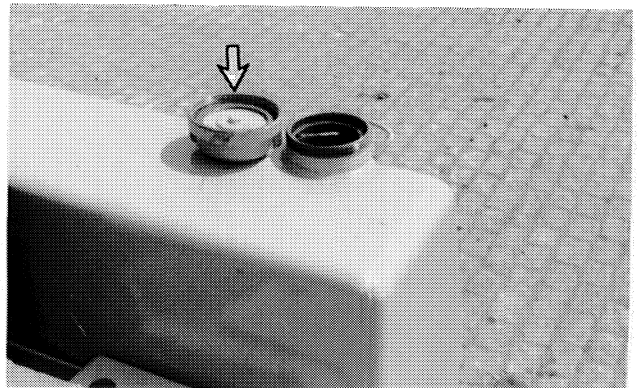

4. Remove the fuel tank fill cap.
5. Disassemble the fuel cap.
6. Wash it in clean, nonflammable solvent.
7. Inspect and replace the tank cap seal if damaged.
8. Put a light coat of oil on the components.
9. Assemble the cap.



**10.** Remove the dipstick.

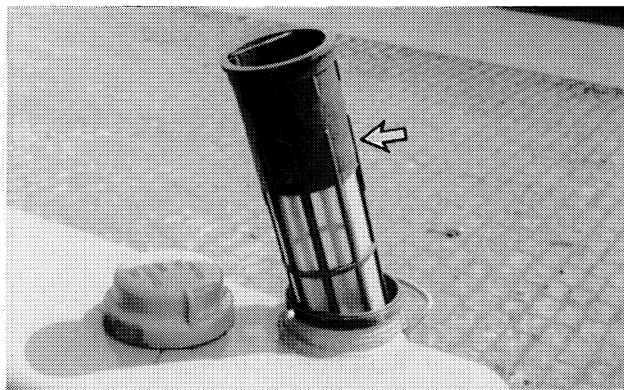

**11.** Remove the strainer.

**12.** Wash the strainer in clean, nonflammable solvent.

**13.** Install the strainer and the dipstick.

**14.** Install the fuel tank cap.

## Engine Crankcase Breather

### Clean

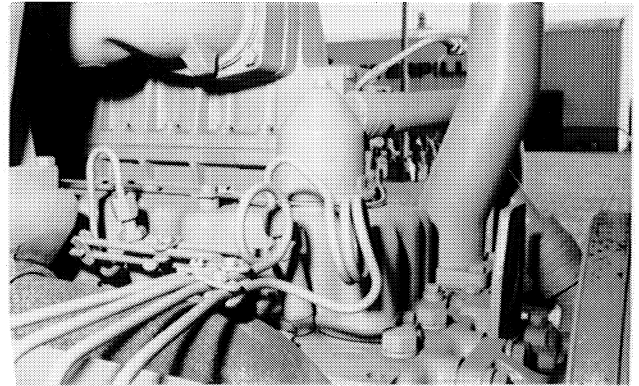

**1.** Loosen the breather outlet hose clamp and remove the hose from the breather cover.

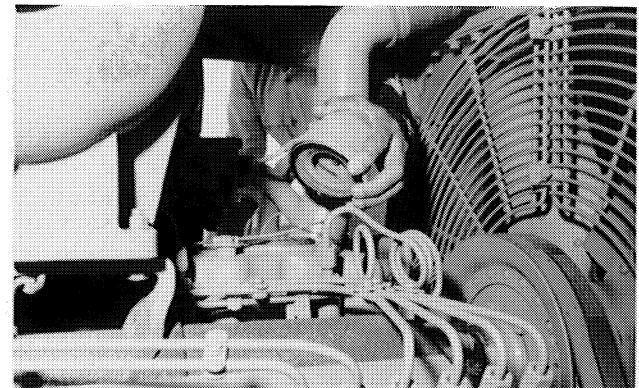

**2.** Loosen the breather retaining bolt and remove the breather.

**3.** Inspect and replace the breather seal if damaged.

**4.** Wash the breather in clean, nonflammable solvent.

**5.** Use pressure air to dry.

**6.** Install the clean breather.

**7.** Tighten the bolt to a torque of  $14 \pm 3 \text{ N}\cdot\text{m}$  ( $10 \pm 2 \text{ lb ft}$ ).

**8.** Install the hose to the breather and tighten the hose clamp.

## Equalizer Bar Pads

### Inspect

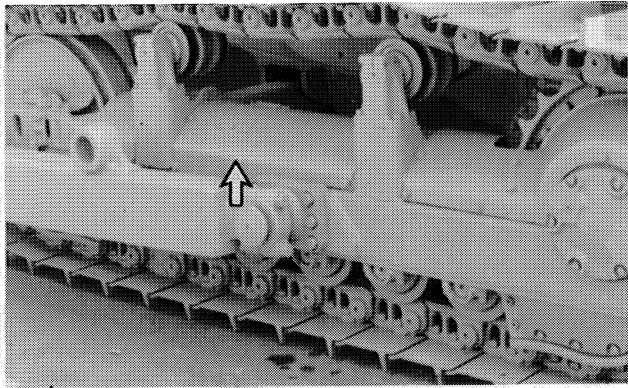

1. Remove the guards.

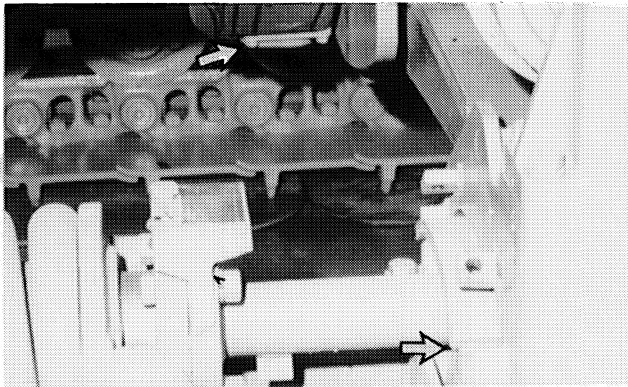

2. Inspect the rubber pads. Replace them if cracked or starting to peel.

Contact your Caterpillar dealer for replacement.

## Sprocket Hub Bearings

### Inspect

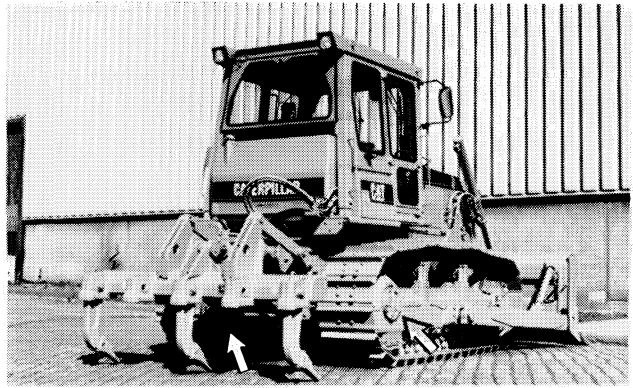

Check for oil leaks on both sides of sprocket. If leakage is noticeable, the seals and/or bearings need to be replaced. Refer to the Service Manual for this procedure. If the Service Manual is not available, contact your Caterpillar dealer.

To check the bearing preload, the machine must be put on stands off the ground to reduce the load on the sprockets. Refer to the Service Manual for this procedure. If the Service Manual is not available, contact your Caterpillar dealer.

## Every 1000 Service Hours or 6 Months

*You must read and understand the warnings and instructions contained in the Safety section of this manual, before performing any operation or maintenance procedures.*

### Power Train Oil System – Power Shift

#### Drain Oil

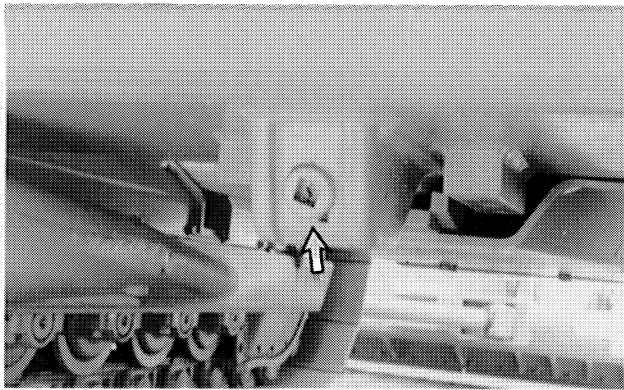

1. Remove the oil drain plug from the bevel gear case.

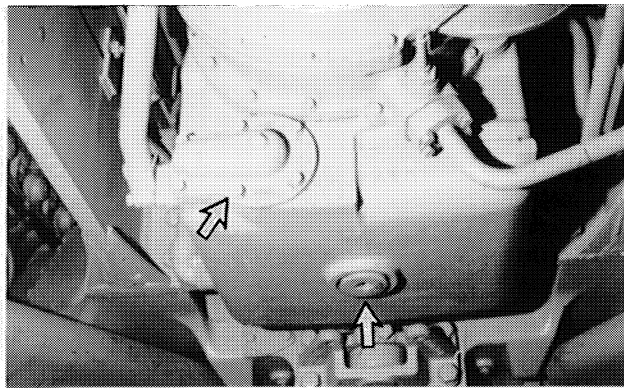

2. Remove the oil drain plug from the torque converter housing.
3. Allow the oil to drain into a suitable container.
4. Clean and install the drain plugs.
5. Remove the cover and screen from the torque converter housing.

6. Wash the cover and screen in clean, nonflammable solvent.
7. Install the cover and screen.

#### Change Filter

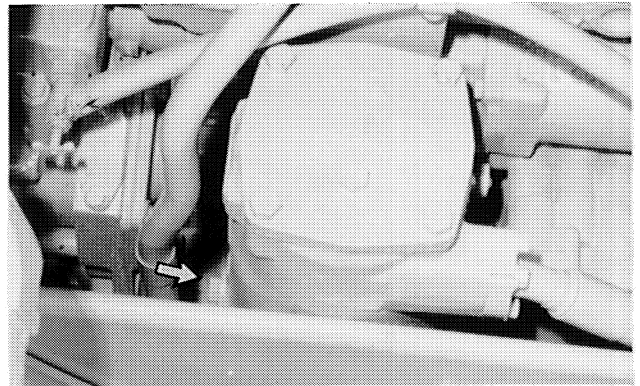

1. Remove the housing drain plug and allow the oil to drain into a suitable container.
2. Remove the cover.

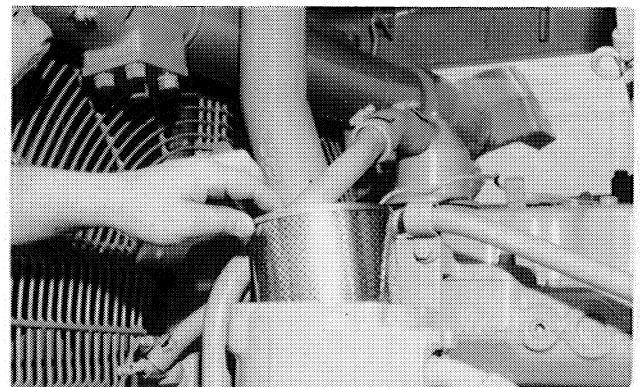

3. Remove the used filter element from the housing and properly discard.
4. Clean the inside of the housing with a clean cloth.
5. Clean the cover and replace the cover seal if damaged.
6. Install the new filter element.
7. Install the housing cover.
8. Clean and install the drain plug.

### Clean Screen, Magnets, and Breather

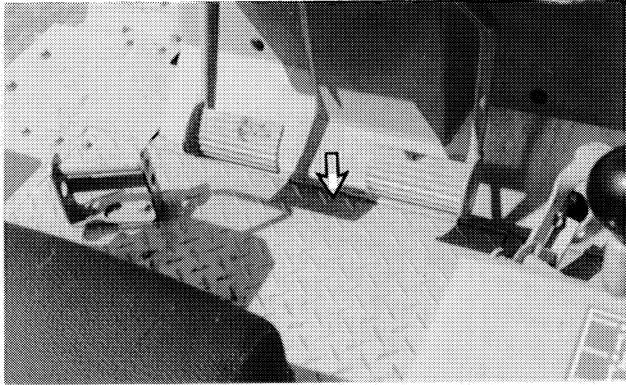

1. Remove the floor plate.

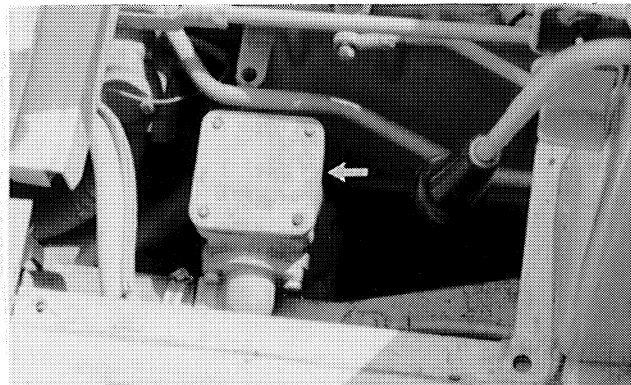

2. Remove the cover.

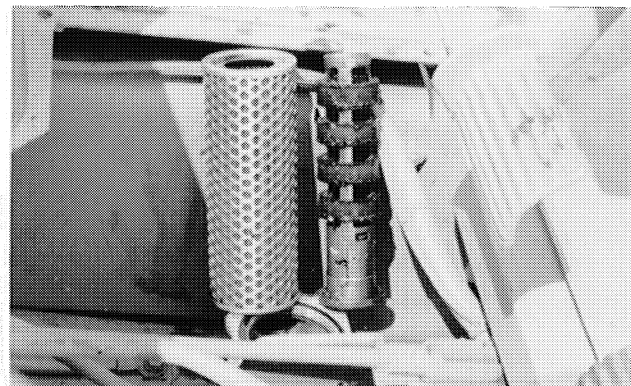

3. Remove the screen and magnets.

---

**NOTICE**

Do not drop or rap the magnets against anything. Replace any damaged magnets.

---

4. Wash the screen and magnets in clean, nonflammable solvent. Clean the magnets with a cloth, stiff brush or pressure air.
5. Install the clean screen and magnets.
6. Inspect the spring and seal. Replace them if damaged.
7. Install the cover and floor plate.

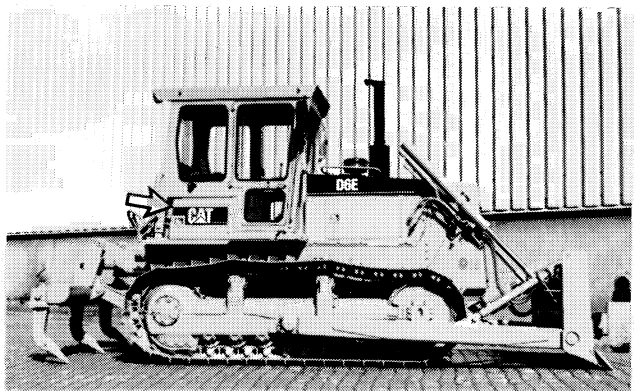

8. Open the right side access cover.

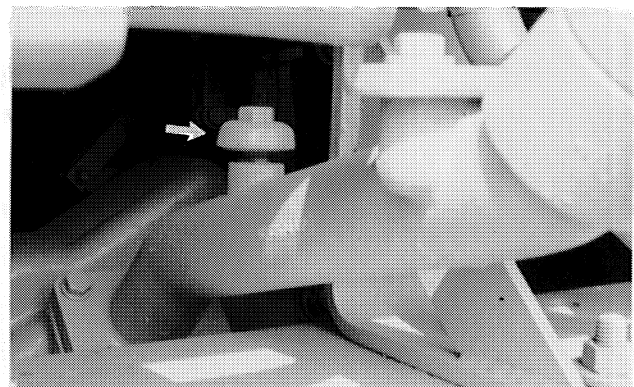

9. Remove the breather.
10. Wash in clean, nonflammable solvent.
11. Install the breather.

## Fill Oil

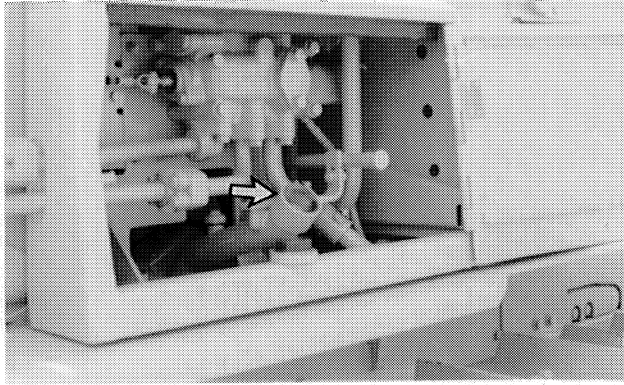

1. Remove the oil filler cap to add oil. See the topic Refill Capacities in the Maintenance Section of this manual.
2. Start and run the engine at LOW IDLE.
3. Maintain the oil between the ADD and FULL marks on the dipstick.
4. Close the door and stop the engine.

## Universal Joint

### Lubricate

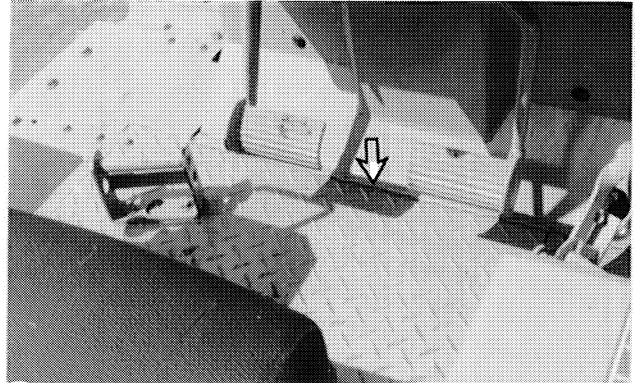

1. Remove the floor plate.

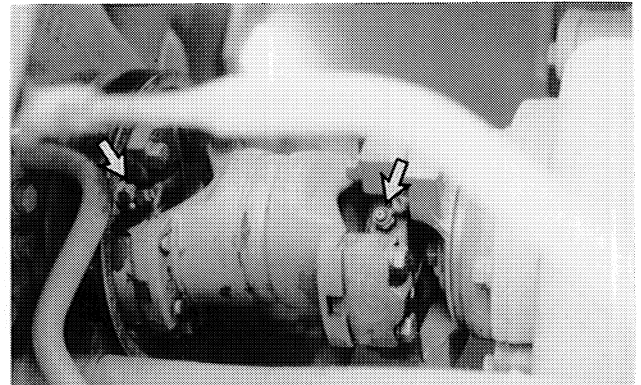

2. Lubricate the two fittings.
3. Install the floor plate.

## Rollover Protective Structure (ROPS)/Falling Object Protective Structure (FOPS) (If Equipped)

### Inspect

#### **WARNING**

To avoid possible weakening of the ROPS (Rollover Protective Structure)/FOPS (Falling Object Protective Structure), contact a Caterpillar dealer before altering the ROPS in any way. The protection offered by the ROPS is reduced if it has been subjected to structural damage.

---



Look for any loose or damaged bolts. Replace damaged bolts or missing bolts with original equipment parts only. Retighten bolts to a torque of  $475 \pm 75$  N•m ( $350 \pm 55$  lb ft).

Note: Apply oil to all ROPS/FOPS bolt threads before installing. Failure to apply oil can result in improper bolt torque.

Replace ROPS/FOPS mounting supports if they rattle or make a noise when the machine is operated on a rough surface.

Do not straighten or repair by welding reinforcement plates to the ROPS/FOPS.

Contact your Caterpillar dealer for repair of cracks in welds, castings or any metal section on the ROPS/FOPS.

## Every 2000 Service Hours or 1 Year

*You must read and understand the warnings and instructions contained in the Safety section of this manual, before performing any operation or maintenance procedures.*

### Hydraulic System

#### Change Oil

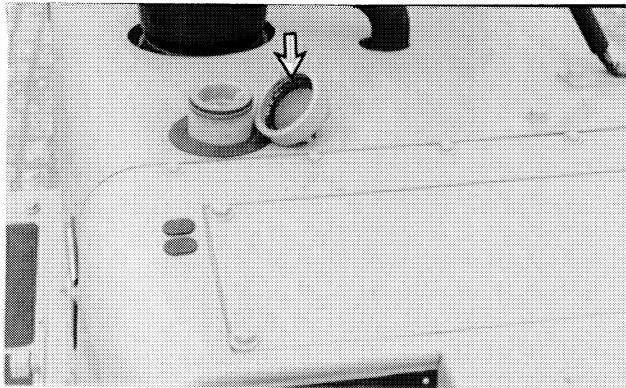

1. Remove the hydraulic oil tank filler cap.

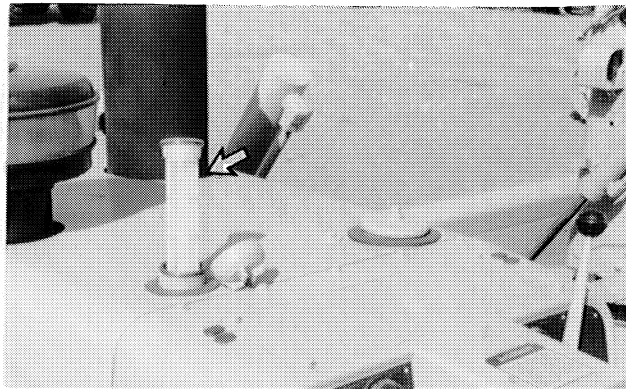

2. Remove the strainer.
3. Wash the filler strainer and filler cap in clean, nonflammable solvent and dry.

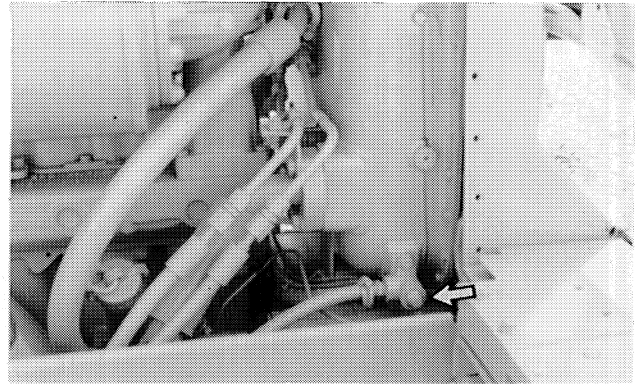

4. Open the oil drain valve and allow oil to drain into a suitable container.
5. Close the valve.
6. Install the strainer.

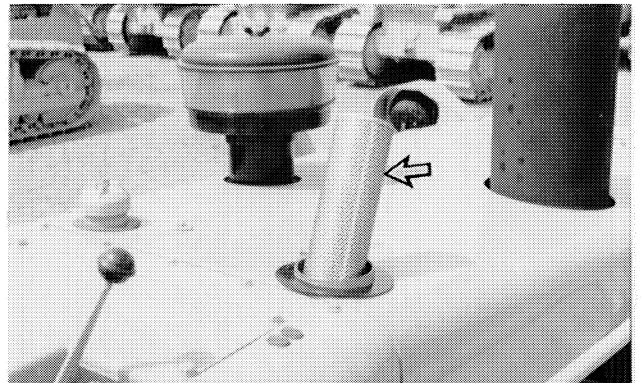

7. Change the hydraulic system filter. See the topic Hydraulic System under Every 500 Service Hours or 3 Months in the Maintenance Section of this manual.
8. Fill the hydraulic system oil tank. See the topic Refill Capacities in the Maintenance Section of this manual.
9. Inspect and replace the filler cap gasket if damaged.
10. Install the oil filler cap.
11. Start and run the engine for a few minutes.
12. Stop the engine.

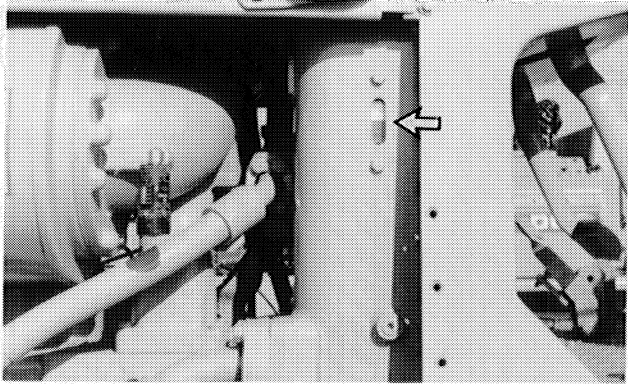

**13.** Maintain the oil level between the ADD and FULL marks in the sight gauge.

## Power Train Oil System – Direct Drive

### Drain Oil

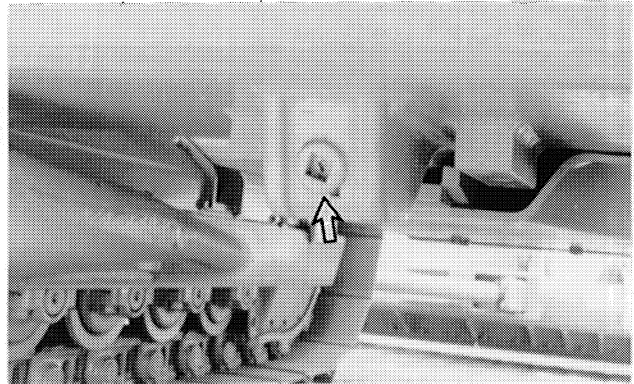

**1.** Remove the drain plug from the bevel gear case and drain the oil into a suitable container.

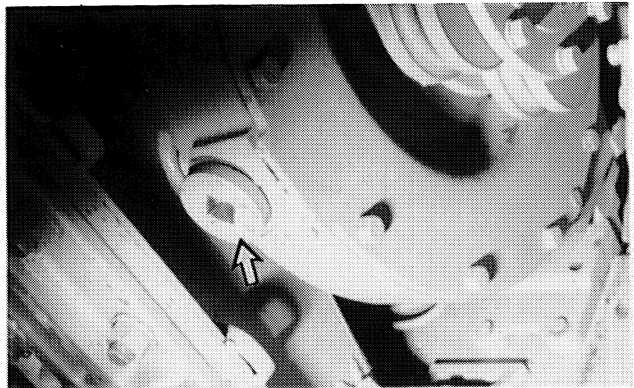

**2.** Remove the drain plug from the flywheel housing and drain the oil into a suitable container.

**3.** Clean and install the drain plugs.

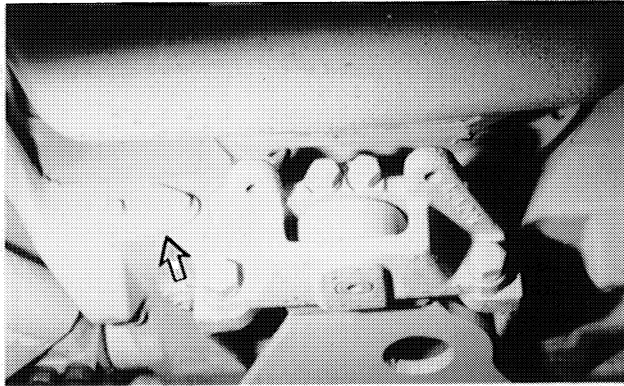

4. Remove the cover and screen from the flywheel housing.
5. Wash them in clean, nonflammable solvent.
6. Install the screen and cover.

### Change Filter

1. Remove the floor plate.

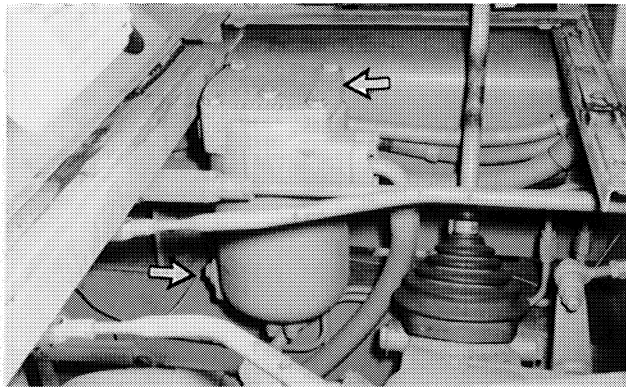

2. Remove the housing drain plug and allow the oil to drain. Remove the cover.

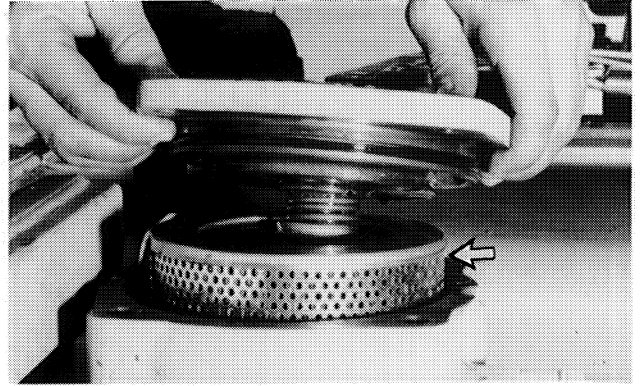

3. Remove and properly discard the used filter element from the housing.
4. Clean the inside of the housing with a clean cloth.
5. Clean the cover and replace the cover seal if damaged.
6. Install the new filter element.
7. Install the housing cover.
8. Clean and install the drain plug.

### Clean Screen, Magnets, and Breather

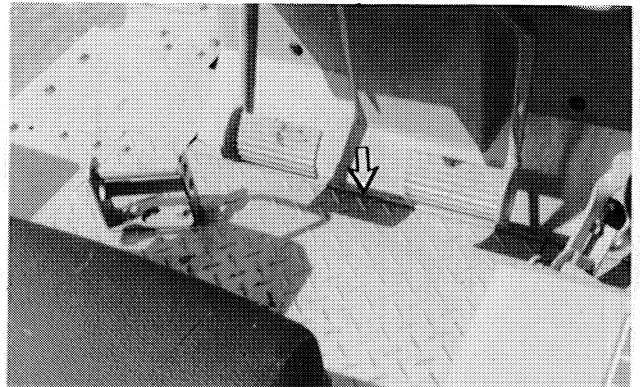

1. Remove the floor plate.

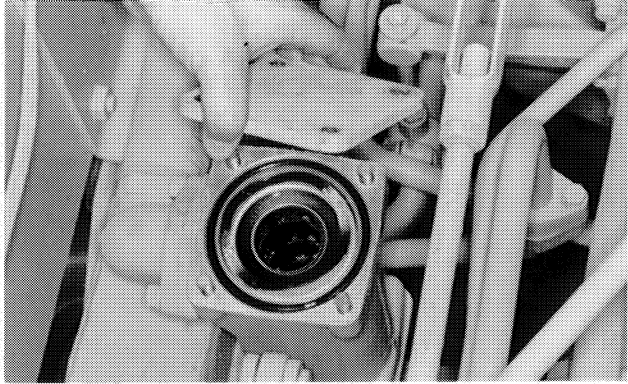

**2.** Remove the cover.

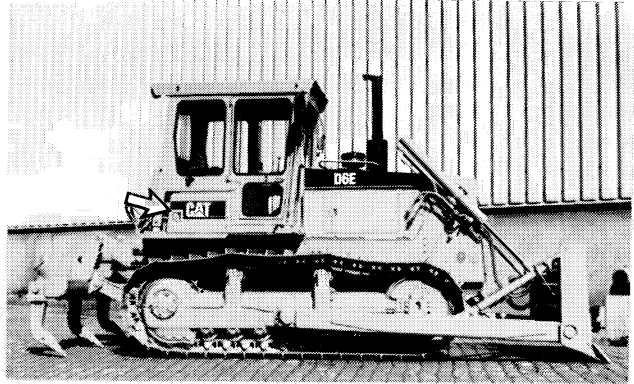

**9.** Open the right side access cover.

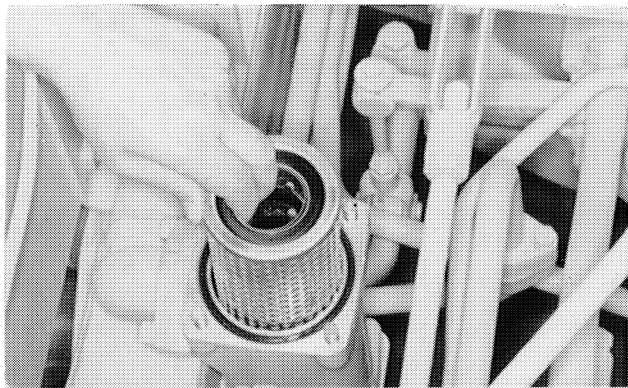

**3.** Remove the screen and magnets.

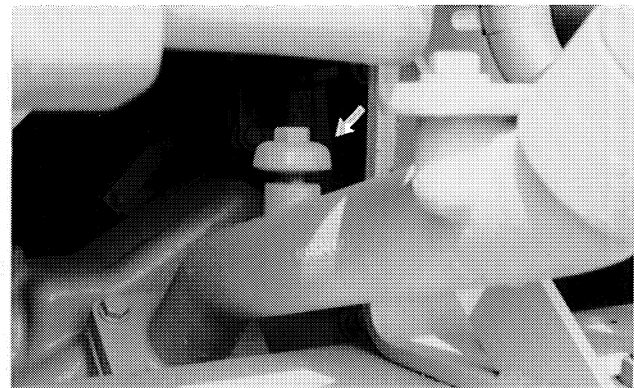

**10.** Remove the breather. Wash in clean, nonflammable solvent. Install the breather.

---

**NOTICE**

Do not drop or rap the magnets against anything.  
Replace any damaged magnets.

---

- 4.** Wash the screen and magnets in clean, nonflammable solvent. Clean the magnets with a cloth, stiff brush or pressure air.
- 5.** Install the magnets.
- 6.** Install the screen.
- 7.** Inspect the spring and seal. Replace them if damaged.
- 8.** Install the cover and floor plate.

## Fill Oil

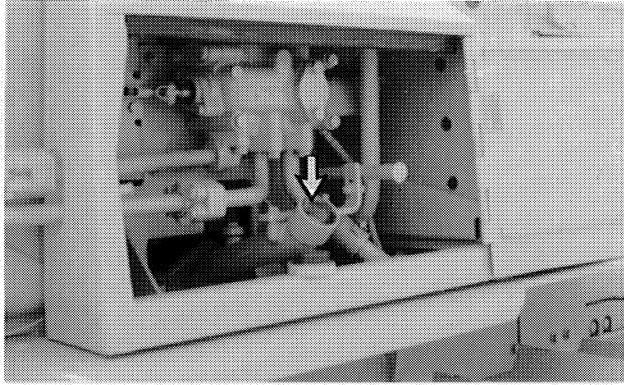

1. Remove the oil filler cap. Fill the Power Train with oil. See the topic Refill Capacities in the Maintenance Section of this manual.
2. Start and run the engine at LOW IDLE.
3. Maintain the oil level between the ADD and FULL marks on the dipstick.
4. Close the door and stop the engine.

## Final Drives

### Change Oil

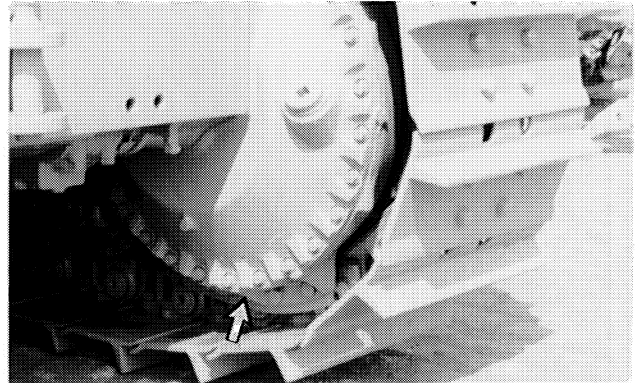

1. Remove the oil filler plug.
2. Remove the drain plug and allow oil to drain into a suitable container.
3. Install the drain plug.

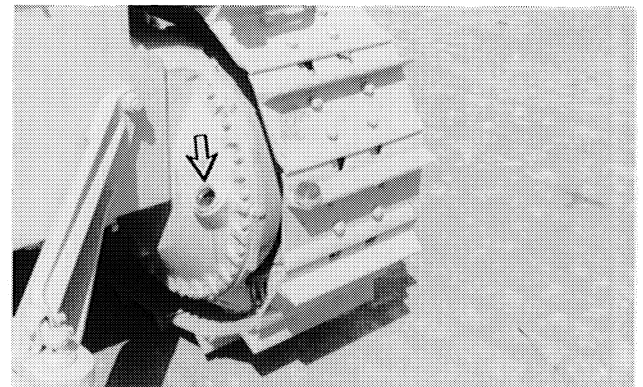

4. Maintain the oil to the bottom of the plug opening.
5. Clean and install the fill plug.
6. Repeat the steps on the other final drive.

## Engine Valve Clearance Setting

### Adjust

**⚠ WARNING**

To prevent possible injury, do not use the starter motor to turn the flywheel.

Hot engine components can cause burns. Allow additional time for the engine to cool before measuring valve clearance.

**NOTICE**

Measure the valve clearance with the engine stopped. To obtain an accurate measurement, allow at least 20 minutes for the valves to cool to engine cylinder head and block temperature.

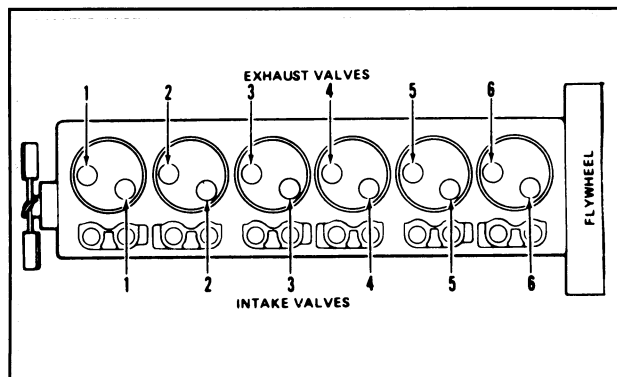

Adjust the valve clearance to within  $\pm 0.08$  mm (.003 in) of the nominal clearance given.

**VALVE CLEARANCE SETTING**

Intake .....	0.38 mm (.015 in)
Exhaust .....	0.64 mm (.025 in)

Refer to the Service Manual or contact your Caterpillar dealer for the complete valve adjustment procedure.

## Engine Valve Rotators

### Check

**⚠ WARNING**

When inspecting the valve rotators, protective glasses or face shield and protective clothing must be worn, to prevent being burned by hot oil spray.

After setting all valve clearances and before installing the valve cover:

1. Start the engine.
2. Move the governor control to LOW IDLE position.

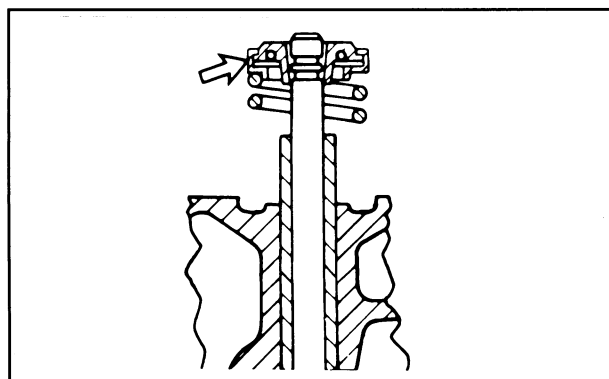

3. Watch the top surface on each valve rotator. Each valve rotator should turn slightly each time the valve closes.

If a valve fails to rotate, contact your Caterpillar dealer.

## Sprocket Hub Bearings

### Adjust

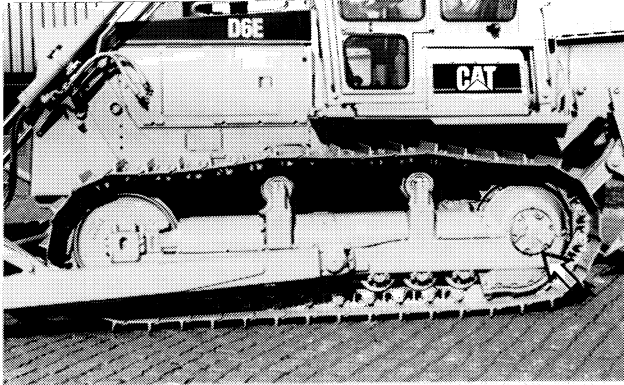

Adjust the preload on the sprocket hub bearings. Refer to the Service Manual for the procedure. If the Service Manual is not available, contact your Caterpillar dealer.

## Every 3000 Service Hours or 2 Years

*You must read and understand the warnings and instructions contained in the Safety section of this manual, before performing any operation or maintenance procedures.*

### Cooling System Coolant

#### Change Coolant – Clean System

---

##### NOTICE

Do not change the coolant until you read and understand the material under Cooling System Specifications in the Maintenance Section of this manual.

---

Drain the coolant earlier whenever the coolant is dirty or foaming is observed.



1. Loosen the radiator cap slowly to relieve pressure.

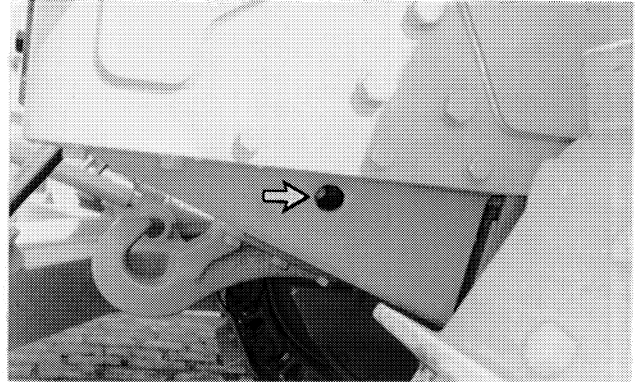

2. Open the drain valve and allow the coolant to drain.
  3. Close the drain valve. Fill the system with clean water and a 6 to 10 percent concentration of cooling system cleaner.
  4. Start and run the engine for 90 minutes. Stop the engine and drain the cleaning solution into a suitable container.
  5. Flush the system with water, with the engine stopped, until the draining water is clear.
  6. Close the drain valve.
  7. Add the coolant solution. See Cooling System Specifications and Lubricant Viscosities and Refill Capacities in the Maintenance Section of this manual.
- NOTE: Do not add supplemental coolant additive or change element at this time, unless you are not using Caterpillar Antifreeze which contains additive.
8. Start the engine and operate it with the radiator cap off, until the thermostat opens and the level stabilizes.
  9. Maintain the coolant level to within 13 mm (.50 in) of the bottom of the fill pipe.
  10. Replace the cap if the gasket is damaged. Install the cap.
  11. Stop the engine.

## Fuel Filter Element – Bosch Fuel System (If Equipped)

### Change

---

#### NOTICE

Do not fill fuel filters with fuel before installing them. Contaminated fuel causes accelerated wear to fuel system parts.

---

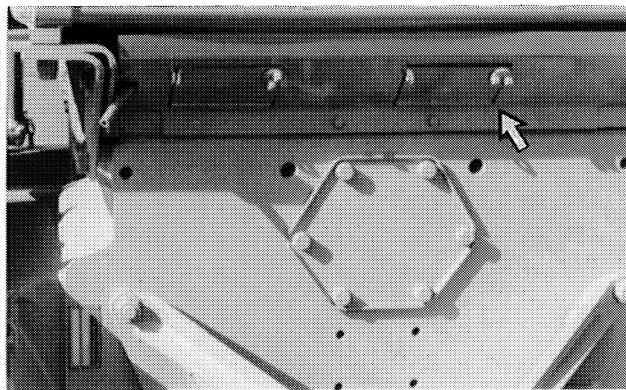

1. Open the fuel shutoff access door.

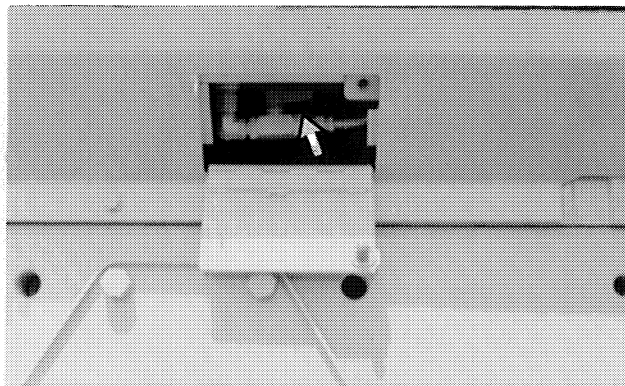

2. Turn the red handle on the fuel supply valve to the right (clockwise) to shut off the fuel supply.

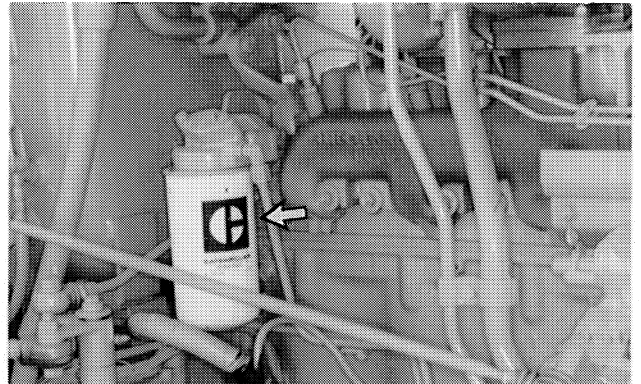

3. Remove and properly discard the filter element.
4. Clean the filter element mounting base.
5. Coat the seal of the new filter element with clean diesel fuel.
6. Install the new filter element by hand. When the seal contacts the base, tighten  $\frac{3}{4}$  turn more.

There are rotation-index marks 90 degrees apart on the filter. Use them as a guide for proper tightening.

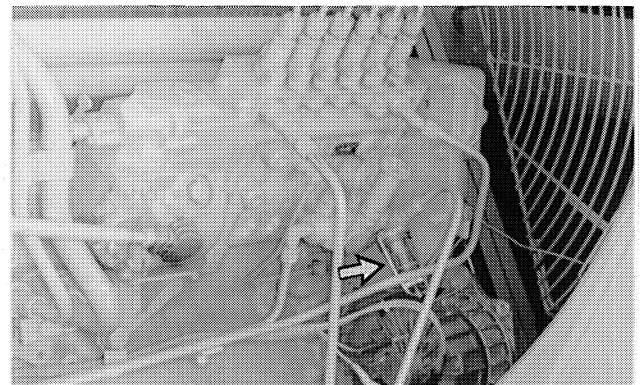

7. Remove the sediment bowl (primary filter).
8. Empty the bowl. Wash in clean nonflammable solvent. Install the bowl.
9. Open the fuel supply valve.
10. Prime the fuel system. (See the following topic.)

### Priming Fuel System

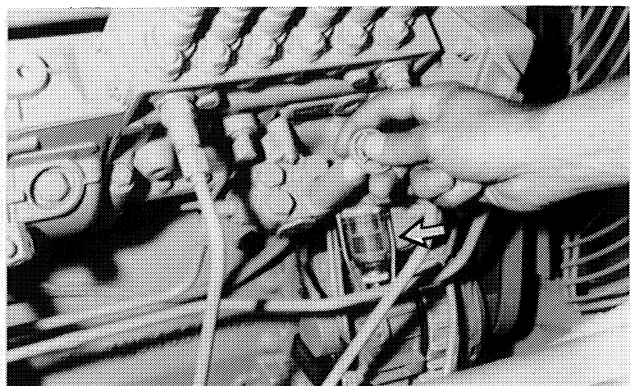

1. Turn the priming pump plunger to the left (counterclockwise) to unlock.
2. Operate the pump until a slight pressure is felt.
3. Turn the plunger to the right (clockwise) to lock.
4. Start the engine and inspect for leaks.