



**67** *Ford*   
**MUSTANG**

**ILLUSTRATED FACTS BOOK**

# PATENT PLATE INFORMATION FOR MODELS AND EQUIPMENT

## VEHICLE WARRANTY NUMBER

7F03 C 100001  
 76A ..... Body Type (Convertible, bucket seats)  
 V ..... Exterior Paint Color (Burnt Amber)  
 2F ..... Type and Color of Interior Trim (Saddle)  
 11L ..... Scheduled Production Date  
 (11th day of November)  
 71 ..... District Number (Los Angeles)  
 2 ..... Rear Axle Ratio (2.83 to 1)  
 1 ..... Transmission Type (3-speed manual)



The warranty plate is located on the left front door lock face panel on all models.

## EXPLANATION OF CODES

7-Last Digit of Model Year (1967). F-Assembly Plant (Dearborn). 03-Patent Plate Code for Mustang Convertible. C-Engine Model (289-Cubic-Inch 2v V-8). 100001-Each Assembly Plant numbers cars in consecutive order, beginning with 100001 each model year.

### BODY TYPE CODE

The body type is identified by a combination numerical-alphabetical code.

Body Serial Code	Body Style Code	Body Type
02	63A	2-Door Fastback -1
01	65A	2-Door Hardtop -1
03	76A	2-Door Convertible -1
02	63B	2-Door Fastback -1,3
01	65B	2-Door Hardtop -1, 3
03	76B	2-Door Convertible -1, 3
01	65C	2-Door Hardtop -2
03	76C	2-Door Convertible -2

1-Bucket Seat    2-Bench Seat    3-Luxury Model

### TRIM CODE

Refer to the Interior-Exterior Trim Combination Chart on page 8 for available trim types and colors and their code numbers. Deviation trim sets use existing trim codes plus a suffix. A numerical suffix denotes trim that is not serviced, i.e., 3B-1, 3B-2, and an alphabetical suffix denotes trim that is serviced, i.e., 3B-A, 3B-B.

### DATE CODE

A number signifying the date precedes the month code letter. A second-year code letter will be used if the model exceeds 12 months.

Month	Code	
	First Year	Second Year
January	A	N
February	B	P
March	C	Q
April	D	R
May	E	S
June	F	T
July	G	U
August	H	V
September	J	W
October	K	X
November	L	Y
December	M	Z

### TRANSMISSION CODE

The transmission type is denoted by a numerical or letter code:

Code	Type
1	3-Speed Manual
3	3-Speed Manual
5	4-Speed Manual
W	Automatic (C4)
U	Automatic (C6)

### ASSEMBLY PLANTS AND CODE LETTERS

F - Dearborn    R - San Jose    T - Metuchen

## DSO CODE

Domestic special orders, foreign special orders, and pre-approved special orders have the complete order number stamped on the plate. If regular production, the DSO space on the plate will carry only the ordering District Number.

Code	District	Code	District
11	Boston	51	Denver
13	New York	52	Des Moines
15	Newark	53	Kansas City
16	Philadelphia	54	Omaha
17	Washington	55	St. Louis
21	Atlanta	61	Dallas
22	Charlotte	62	Houston
24	Jacksonville	63	Memphis
25	Richmond	64	New Orleans
27	Cincinnati	65	Oklahoma City
28	Louisville	71	Los Angeles
32	Cleveland	72	San Jose
33	Detroit	73	Salt Lake City
34	Indianapolis	74	Seattle
35	Lansing	75	Phoenix
37	Buffalo	81	Ford of Canada
38	Pittsburgh	83	Government
41	Chicago	84	Home Office Reserve
42	Fargo	85	American Red Cross
43	Milwaukee	89	Transportation Services
44	Twin Cities	90-99	Export
45	Davenport		

## AXLE CODE

The rear axle ratio is denoted by a numerical code. Limited-Slip type rear axles are denoted by a letter code.

	0	1	2	3	4
Regular:					
Limited-Slip:	—	A	B	C	D
Ratio:	3.10	3.00	2.83	3.20	3.25
Regular:	5	6	8	9	
Limited-Slip:	E	F	G	H	
Ratio:	3.50	2.80	2.75	4.11	

## ENGINE CODE

Engines for domestic use are denoted by the use of code letters. Numerals are used for low compression export engines.

Code	Type
T	6-Cyl. 200 Cu. In. (IV)
2	6-Cyl. 1 200 Cu. In. (IV)
C	8-Cyl. 289 Cu. In. (2V)
3	8-Cyl. 1 289 Cu. In. (2V)
A	8-Cyl. 289 Cu. In. (4V) Prem. Fuel
K	8-Cyl. 289 Cu. In. (4V) Hi-Perf.
S	8-Cyl. 390 Cu. In. (4V)
W	8-Cyl. 427 Cu. In. (4V) Hi-Perf.
R	8-Cyl. 427 Cu. In. (8V) Hi-Perf.

1 Low Compression

## COLOR CODE

Refer to the Interior-Exterior Trim Combination Chart on page 8 for available colors and their code numbers. If a special paint is used, the color space on the warranty plate will not be stamped.

# MUSTANG HARDTOP



65A HARDTOP



## EXTERIOR STYLING AND FEATURES

Mustang — America's foremost "fun-to-drive" car, has all-new body sheetmetal for 1967, imparting a fresh new look to its trend setting styling concept.

- Deeply inset grille with a crisp mesh appearance accentuates the apparent length of the hood. Familiar "corralled" Mustang ornament is positioned at grille center. Entire grille is outlined with bright-metal moldings.
- Highly sculptured body side panels that terminate with twin simulated air scoops add emphasis to the low, long look.
- Remote control outside rearview mirror is standard.
- FORD on the hood leading edge, MUSTANG lettering and emblem on the front fenders, and MUSTANG lettering on the deck lid provide attractive product identification.
- Windshield, recessed rear window, and curved side windows are tastefully outlined with bright-metal trim.
- Three bright-metal trimmed taillights/turn signals are located at either side of the concave rear body panel.
- Standard equipment back-up lights are below the bumper in the lower panel.
- Styled fuel filler cap features three-blade "knock-off" design with a Mustang emblem displayed at center.

## INTERIOR STYLING AND FEATURES

- All-new sports styled interior with foam-padded twin bucket seats.
- New door trim panels with horizontal pleated design, trimmed with bright mylar moldings.
- Choice of seven all-vinyl trims — black, blue, red, saddle, ivy gold, aqua and parchment.
- New instrument panel and cluster. Large, easy to read gauges for fuel, oil pressure, amps and temperature.
- Large, pullout ash tray with concealed cigarette lighter.
- All major items, including the headlining, are color-keyed to the interior trim selection.
- Expanded standard safety package.
- New dome-light with door-operated courtesy switches.
- Additional standard equipment features — 16-inch three-spoke steering wheel . . . long wearing nylon-rayon carpeting molded to the floor contour . . . suspended accelerator pedal . . . front seat arm rests.

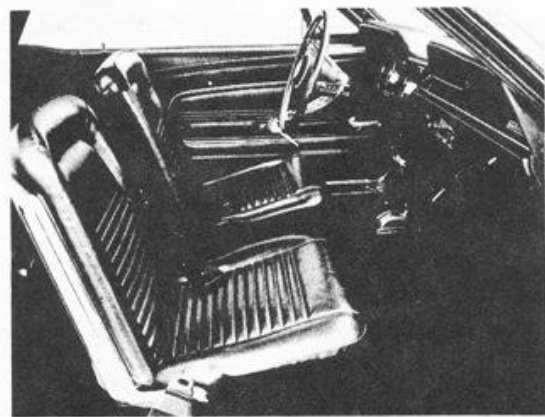

## MAJOR SPECIFICATIONS

Wheelbase	108"
Tread — Front	6-Cyl. - 57.9" — V-8 - 58.1"
— Rear	6-Cyl. - 57.9" — V-8 - 58.1"
Length — Overall	183.6"
Width — Overall	70.9"
Height — Overall	51.6"
Usable Luggage Capacity	9.2 cu ft

Front Compartment Dimensions —	
Effective Head Room	37.4"
Maximum Effective Leg Room	41.8"
Hip Room	53.9"
Shoulder Room	53.4"
Curb Weight (6-Cyl. — Std. Transmission)	2696 lbs



# MUSTANG CONVERTIBLE



## EXTERIOR STYLING AND FEATURES

America's most popular Convertible has all-new body sheetmetal for a bold, fresh new look. Longer and wider, it presents a true sports car appearance.

- Deeply inset grille with a crisp mesh appearance accentuates the lengthy appearance of the hood. Familiar "corralled" Mustang ornament is positioned at grille center. Entire grille is outlined with bright-metal moldings.
- Sculptured body side panels that terminate into twin simulated air scoops add emphasis to the low, long look.
- Remote control outside rearview mirror is standard equipment.
- Convertible top is five-ply vinyl available in black or white. Top boot is all-vinyl, color-keyed to interior.
- FORD on the hood, MUSTANG lettering and emblem on the front fenders, and MUSTANG lettering on the deck lid provide attractive product identification.
- Windshield and curved side windows are tastefully outlined with bright-metal trim.
- Three bright-metal trimmed taillights/turn signals are located at either side of the concave rear body panel. Standard equipment back-up lights are below the bumper in the lower panel.
- Style fuel filler cap features "knock-off" design.

## INTERIOR STYLING AND FEATURES

- All-new sports styled interior with foam-padded twin bucket seats.
- New door trim panels with horizontal pleated design.
- Choice of seven all-vinyl trims — black, blue, red, saddle, ivy gold, aqua and parchment.
- New instrument panel and cluster. Large, easy to read gauges for fuel, oil pressure, amps and temperature.
- Large, pullout ash tray with concealed cigarette lighter.
- All major items are color-keyed to the interior trim selection.
- Expanded standard safety package.



- Additional standard equipment features — 16-inch three-spoke steering wheel . . . long wearing nylon-rayon carpeting molded to the floor contour . . . suspended accelerator pedal . . . front seat arm rests . . . instrument-panel-mounted glove box . . . courtesy lights under instrument panel operated by door switches.



## MAJOR SPECIFICATIONS

Wheelbase . . . . .	108"
Tread — Front . . . . .	6-Cyl.-57.9" — V-8-58.1"
— Rear . . . . .	6-Cyl.-57.9" — V-8-58.1"
Length — Overall . . . . .	183.6"
Width — Overall . . . . .	70.9"
Height — Overall . . . . .	51.6"
Usable Luggage Capacity . . . . .	7.7 cu ft

Front Compartment Dimensions —	
Effective Head Room . . . . .	37.8"
Maximum Effective Leg Room . . . . .	41.8"
Hip Room . . . . .	53.9"
Shoulder Room . . . . .	53.4"
Curb Weight (6-Cyl. — Std. Transmission) . . . . .	2856 lbs

# MUSTANG 2+2 FASTBACK

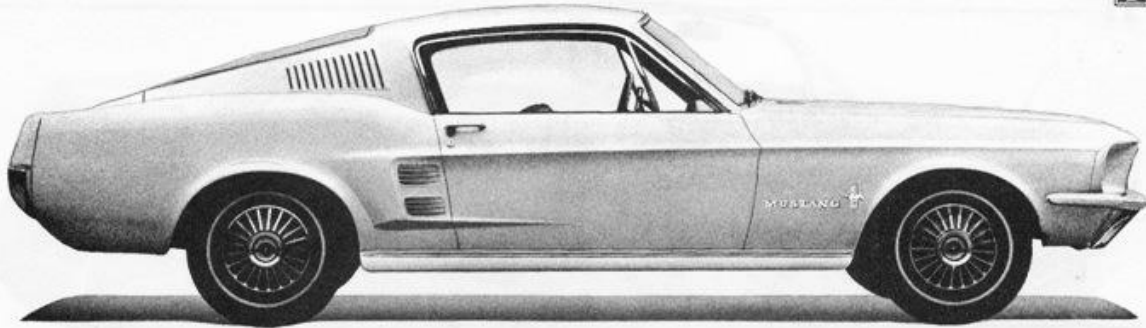

63A 2 + 2 FASTBACK



## EXTERIOR STYLING AND FEATURES

For 1967, the 2 + 2 Fastback has been completely restyled with all-new body sheetmetal and roof, portraying even more of the "Gran Turismo" sports flair. The new roof presents a sleek swept-back appearance with smooth flowing lines. The large rear window and short deck lid are fully integrated into the design, carrying the roofline to the extreme rear of the car. A series of thin air louvers are positioned on the roof rear quarter, and are a part of the functional flow-through ventilation system.

Below the roof, the 2 + 2 Fastback is similar to the Hardtop and Convertible.

- Deeply inset grille with a crisp mesh appearance. Familiar Mustang ornament positioned at grille center.
- New radial spoke design wheel covers are standard.
- Highly sculptured body side panels that terminate into twin simulated air scoops. Full-length bright-metal rocker panel molding.
- FORD on the hood leading edge, MUSTANG lettering and emblem on the front fenders, and MUSTANG lettering on the deck lid.
- Bright-metal window trim all-around.
- Three bright-metal trimmed taillights/turn signals at either side of the concave rear panel. Back-up lights in lower rear panel. Fuel filler cap with styled "knock-off" design that displays a Mustang emblem.

## INTERIOR STYLING AND FEATURES

- All-new sports styled interior with foam-padded twin bucket seats. Rear seat is fixed in place with sport deck optional.
- New door trim panels with horizontal pleated design, trimmed with bright-metal moldings. Choice of seven all-vinyl trims — black, blue, red, saddle, ivy gold, aqua and parchment.
- New instrument panel and cluster. Large, easy to read gauges for fuel, oil pressure, amps and temperature.
- All major items, including the headlining, are color-keyed to the interior trim selection.
- Expanded standard safety package.
- Additional standard features — 16-inch three-spoke steering wheel . . . long wearing nylon-rayon carpeting molded to the floor contour . . . suspended accelerator pedal . . . front seat arm rests . . . instrument-panel-mounted glove box . . . courtesy lights under instrument panel and quarter trim panels operated by door switches.

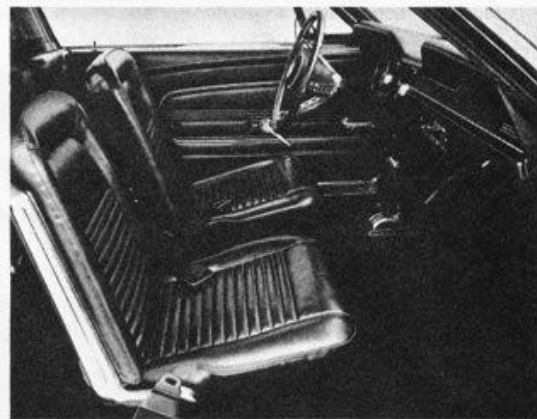

## MAJOR SPECIFICATIONS

Wheelbase . . . . .	108"
Tread — Front . . . . .	6-Cyl.-57.9" — V-8-58.1"
— Rear . . . . .	6-Cyl.-57.9" — V-8-58.1"
Length — Overall . . . . .	183.6"
Width — Overall . . . . .	70.9"
Height — Overall . . . . .	51.6"
Usable Luggage Capacity . . . . .	5.1 cu ft

Front Compartment Dimensions —	
Effective Head Room . . . . .	37.3"
Maximum Effective Leg Room . . . . .	41.8"
Hip Room . . . . .	53.9"
Shoulder Room . . . . .	53.4"
Curb Weight (6-Cyl. — Std. Transmission) . . . . .	2723 lbs



# MUSTANG POWER TEAMS

## POWER TEAM AVAILABILITY

The 1967 Mustang is available with 13 engine-transmission combinations — ranging from the economical 200 Six with a three-speed manual transmission to the powerful 390 4v GT V-8 with four-on-the-floor. With this wide selection, buyers can tailor a power team to fit their motoring needs.

## ENGINES

The 200-cubic-inch Six with a rating of 120 horsepower is standard equipment with all Mustangs. Where initial cost is the prime requisite, this engine is the logical choice. It provides spirited performance and maximum economy of operation. Features include a seven main bearing crankshaft that provides ultra-smooth operation, a dual element choke for all-weather good starting, and redesigned combustion chambers for maximum efficiency.

The 289-cubic-inch 2v V-8 with a 200-horsepower rating is the base optional engine. The most popular of Ford engines, it provides excellent performance in a car of Mustang's size. Features include the use of regular grade fuel, a new valve train that increases durability, and a new 2-venturi carburetor.

The optional 289-cubic-inch 4v V-8 provides a further increase in performance with a rating of 225 horsepower. Under normal driving conditions, it uses only a small percentage of its horsepower, with a large reserve ready for emergency situations. A new Autolite carburetor has been installed for 1967 that increases efficiency and performance through the entire driving range.

The third optional V-8 engine is the 289-cubic-inch 4v High-Performance V-8 with a rating of 271 horsepower. Proven in thousands of performance events, this engine delivers outstanding performance with the utmost reliability. Included with this engine are special drive line and suspension components and F-70-14 WSW Wide-Oval tires on six-inch rims. Available with GT Equipment Group and either 4-speed manual or Cruise-O-Matic at extra cost.

The top engine for 1967 is the 390-cubic-inch 4v GT V-8. With its 320-horsepower rating, it provides commanding performance in any driving situation. Like the 289 High-Performance V-8, it includes special drive line and suspension components and F-70-14 WSW Wide-Oval tires on six-inch rims. Available with or without GT Equipment Group.

## TRANSMISSIONS

Three-speed manual transmissions are included as standard equipment with all engines except the 289 High-Performance and 390 GT V-8's. These transmissions are the constant-mesh type that fully synchronize in all forward gears.

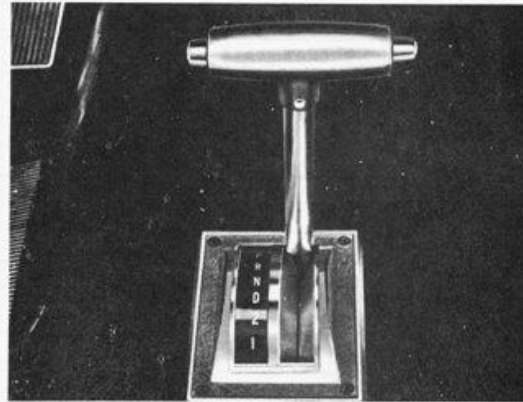

Available with all engines, the smooth shifting Select Shift Cruise-O-Matic transmission features an extremely versatile shift pattern for 1967. This shifting arrangement permits both manual and fully automatic operation — whichever the driver desires for the immediate road conditions or driving situation.

A four-speed constant-mesh manual transmission is optional with all engines except the 200 Six. This transmission is fully synchronized in all forward gears, permitting upshifts and downshifts at reasonable car speeds without gear clash or noise. When ordered with 289 4v High-Performance or 390 4v engine it will include tachometer and trip odometer.

## POWER TEAM SELECTION

ENGINES	TRANSMISSIONS			REAR AXLE RATIOS					
	3-Speed* Manual	4-Speed Manual	Cruise- O-Matic	3-Speed*		4-Speed		Cruise- O-Matic	
				Std.	Opt.	Std.	Opt.	Std.	Opt.
Std. — 200 Six — 120 HP	Std.	N/A	Opt.	3.20	—	—	—	2.83	3.20
Opt. — 289 2v V-8 — 200 HP	Std.	Opt.	Opt.	2.80	3.00++	2.80	**3.00+	2.80	**3.00+
Opt. — 289 4v V-8 — 225 HP	Std.	Opt.	Opt.	3.00+	—	3.00+	—	3.00+	—
Opt. — 289 4v Hi-Perf. V-8 — 271 HP	N/A	Opt.	Opt.	—	—	3.50	3.89	3.50	3.89
Opt. — 390 4v GT V-8 — 320 HP	#	Opt.	Opt.	3.00	3.25++	3.00	3.25++	3.00	3.25++

\* 3-Speed fully synchronized transmission.

\*\* Mandatory ratio with F-70-14 Wide-Oval tires.

+ Also available with optional limited-slip differential.

++ Available only with optional limited-slip differential.

# HD 3-Speed Manual req'd. at extra cost.

# MUSTANG COLOR AND TRIM



INTERIOR TRIM AND CODE ALL-VINYL		EXTERIOR COLORS AND CODE															
		A	B	E	I	K	M	Q	T	V	W	X	Y	Z	4	6	8
		Raven Black	Frost Turquoise	Beige Mist	Lime Gold	Nightmist Blue	Wimbledon White	Brittany Blue	Candyapple Red	Burnt Amber	Clearwater Aqua	Vintage Burgundy	Dark Moss Green	Sauterne Gold	Silver Frost	Pebble Beige	Springtime Yellow
<b>STANDARD BUCKET SEATS</b>																	
Black	2A	X	X	X	X	X	X	X	X	X	X	X	X	X	X	X	X
Blue	2B	X				X	X	X							X		
Red	2D	X							X			X			X		
Saddle	2F	X		X			X			X			X			X	X
Ivy Gold	2G	X			X		X						X	X			
Aqua	2K	X	X				X				X						
Parchment	2U	X	O	X	O	O	X	O	X	X	O	X	X	O		X	X
<b>INTERIOR DECOR GROUP OPTION BUCKET SEATS</b>																	
Black	6A	X	X	X	X	X	X	X	X	X	X	X	X	X	X	X	X
Blue	6B	X				X	X	X							X		
Red	6D	X					X		X		X				X		
Saddle	6F	X		X			X			X			X			X	X
Ivy Gold	6G	X			X		X						X	X			
Aqua	6K	X	X				X				X						
Parchment	6U	X	O	X	O	O	X	O	X	X	O	X	X	O		X	X
<b>FULL-WIDTH SEAT OPTION (Hardtop and Convertible)</b>																	
Black	4A	X	X	X	X	X	X	X	X	X	X	X	X	X	X	X	X
Parchment	4U	X	O	X	O	O	X	O	X	X	O	X	X	O		X	X
<b>STANDARD BUCKET SEATS W/COMFORT-WEAVE OPTION (Hardtop and 2 + 2 Fastback)</b>																	
Black	7A	X	X	X	X	X	X	X	X	X	X	X	X	X	X	X	X
Parchment	7U	X	O	X	O	O	X	O	X	X	O	X	X	O		X	X
<b>INTERIOR DECOR GROUP OPTION W/COMFORT-WEAVE SEAT OPTION (Hardtop and 2 + 2 Fastback)</b>																	
Black	5A	X	X	X	X	X	X	X	X	X	X	X	X	X	X	X	X
Parchment	5U	X	O	X	O	O	X	O	X	X	O	X	X	O		X	X
<b>ACCENT PAINT STRIPE OPTION</b>																	
Black			X	X	X		X		#X	X				X	X	X	X
White		X				X		X	X		X	X	X				
Red		#X					*X								*X		
<b>STRIPES W/GT OPTION</b>																	
Black			X	X	X		X		#X	X				X	X	X	X
White		X				X		X	X		X	X	X				
Red		*X					*X								*X		
Medium Blue							†X										

CONVERTIBLE TOPS—Available in black or white with all exterior colors.  
 HARDTOP VINYL ROOF OPTION—Available in black or pastel parchment with all exterior colors.  
 TWO-TONE REAR BODY PANEL OPTION—Available in dark gray metallic with all exterior colors.

X—Recommended. O—Also Available. \*Red stripe only with red interior.  
 †Black stripe only with black interior. ‡Medium blue stripe only with blue interior.



# MUSTANG FEATURES

## STANDARD EQUIPMENT

	Hardtop	Convertible	2 + 2 Fastback		Hardtop	Convertible	2 + 2 Fastback
Air Cleaner Filter*	X	X	X	Heater and Defroster - Fresh Air	X	X	X
Accelerator Pedal - Suspended - Type	X	X	X	Hood Latch - Single - Action	X	X	X
Alternator - 38 - Amp	X	X	X	Horns - Dual	X	X	X
Ash Tray - Front	X	X	X	Instrument Panel - Padded	X	X	X
Arm Rests - Front - Energy - Absorbing	X	X	X	Insulated Body	X	X	X
Arm Rests - Ash Trays - Rear	X	X	X	Jack, Scissors - Type - Body Side	X	X	X
Back - Up Lights	X	X	X	Lamps Bulbs - Extended - Life	X	X	X
Battery - "Sta - Ful" Design	X	X	X	Lubrication, Chassis - 36,000 - Mile	X	X	X
Body - Rust Resistant	X	X	X	Maintenance - Twice - A - Year	X	X	X
Brakes - Self - Adjusting - Dual System	X	X	X	Mirror - Inside Rearview, Day/Nite	X	X	X
Bucket Seats - Foam - Padded, Adjustable	X	X	X	Mirror - Outside Rearview - Remote Control	X	X	X
Carpets - Nylon - Rayon, Molded	X	X	X	Molding - Rocker Panel	X	X	X
Choke - Automatic	X	X	X	Muffler - Aluminized	X	X	X
Cigarette Lighter	X	X	X	Oil Filter - 6,000 - Mile	X	X	X
Coat Hooks	X	X	X	Scuff Plates - Aluminum	X	X	X
Coolant - 2 - Year or 36,000 - Mile	X	X	X	Seat Belts - Front and Rear	X	X	X
Courtesy Lights - Door Switches	X	X	X	Steering Wheel - Deep - Dish, Safety - Type	X	X	X
Curved Side Glass	X	X	X	Sun Visors - Padded, Color - Keyed	X	X	X
Door Checks - Two - Stage	X	X	X	Thermostat - 195 - Degree	X	X	X
Door Hinges - Bronze - Bushed	X	X	X	Transmission Lever - Tunnel - Mounted	X	X	X
Door Latches - Bear - Hug	X	X	X	Transmission - 3 - Speed Manual	X	X	X
Door Trim - All - Vinyl	X	X	X	Turn Signals - w/Lane Change	X	X	X
Emergency Flashers, 4 - Way	X	X	X	Upholstery - All - Vinyl	X	X	X
Engine - 200 Six	X	X	X	Valve Lifters - Hydraulic	X	X	X
Finish - Super Diamond Lustre Enamel	X	X	X	Ventilation - Cowl - Aire Intakes	X	X	X
Front Fenders - Bolt - On	X	X	X	Ventilation - Cowl - Aire plus Roof Vent Outlets	X	X	X
Fuel Tank - 16 - Gallon	X	X	X	Wheel Covers - Full	X	X	X
Glass - Safety	X	X	X	Windshield Washers	X	X	X
Glove Box - Instrument - Panel - Mounted	X	X	X	Windshield Wipers - 15" Electric - 2 - Speed	X	X	X
Headlining - Color - Keyed Vinyl	X	X	X				

\* 12,000 miles with closed crankcase emission system.

## SAFETY FEATURES

A broad range of new and improved safety features will be standard equipment on all 1967 Mustang models. Highlights of these safety features are:

**DUAL HYDRAULIC BRAKE SYSTEM WITH WARNING LIGHT** - Dual master cylinders control the front brakes and the rear brakes independently. Should there be a fluid loss in the front brakes, the rear brakes will still be operational, and vice versa. If a leak should develop, the driver is alerted by a warning light on the instrument panel that lights when the brakes are applied and signals the need for immediate repairs.

**4-WAY EMERGENCY FLASHER** - The driver can put all four turn signals into operation simultaneously to warn of an emergency situation. The emergency flasher control switch is located conveniently on the right side of the steering column.

**ENERGY-ABSORBING ARM RESTS** - The 1967 Mustang's new arm rests have energy-absorbing properties in a lateral plane, yet they provide firm vertical arm support with a soft foam cushion. The new design has a polypropylene honeycomb-type core surrounded and filled with urethane foam and covered with soft vinyl. The honeycomb is positioned

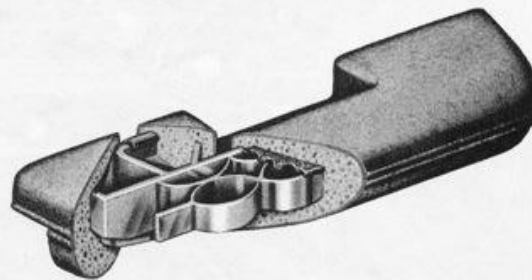

vertically to give the necessary strength, yet will collapse laterally to minimize the possibility of injury during a collision.

**IMPACT-ABSORBING STEERING WHEEL WITH DEEP-PADDED HUB** - The impact-absorbing deep-dish steering wheel, pioneered by Ford, is now supplemented by the addition of a deep-padded hub designed to progressively collapse on impact. The hub consists of an inner core of molded urethane foam, an outer layer of polyvinylchloride, covered with soft vinyl. The steering wheel also yields on impact, yet gives firm control when driving.

**REARVIEW MIRRORS** - A day/nite inside mirror with shatter resistant flexible backed glass and break-

# MUSTANG FEATURES

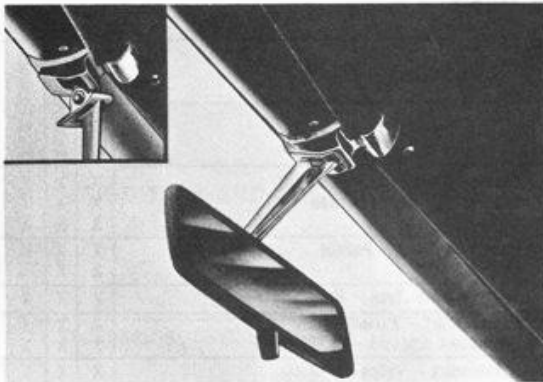

away or double pivot support and an outside remote control mirror are standard equipment on all 1967 Mustang models.

**POSITIVE DOOR LOCK BUTTONS** — To prevent inadvertent opening of car doors from the inside, all Mustang inside lock buttons are of the non-overriding type. Once the lock button is depressed, the door handle will not override and unlock the door. The driver or passenger must first lift the button, then open the door with the handle.

**TURN INDICATORS WITH LANE-CHANGING SIGNAL FEATURE** — This new feature, when used properly, will eliminate driving with the turn signals operating after a lane change maneuver has been completed. The driver holds the turn indicator lever in an intermediate position to signal his intention to change lanes to either right or left. When the lever is released, a spring returns it to the straightaway posi-

tion, cancelling the signal. Turn signals operate in the conventional way.

**PADDED INSTRUMENT PANEL** — Safety padding used on the Mustang instrument panel contains extra energy-absorbing properties. The padding is formed to the contour of the instrument panel providing a convenient hood over the instruments to minimize glare and reflection. It is covered with a low-gloss vinyl.

**TWO-SPEED WINDSHIELD WIPERS AND WINDSHIELD WASHERS** — Electric powered two-speed windshield wipers give more reliable, consistent action under all driving conditions. Windshield washers, when put into operation, automatically energize the wipers. Both washers and wipers feature easy operation and positive action.

## ADDITIONAL STANDARD SAFETY FEATURES—

- Front and rear seat belts.
- Front seat belt retractors.
- Padded sun visors.
- Padded windshield pillars.
- Thick laminate safety plate glass windshield.
- Safety designed instrument panel and controls.
- Reduced glare instrument panel and wiper arms and blades.
- Double-yoke safety door latches and safety hinges.
- Back-up lights.
- Uniform shift quadrant with automatic transmission.
- Front seat shoulder harness anchors.
- Tire safety rims.
- Corrosion-resistant brake lines.

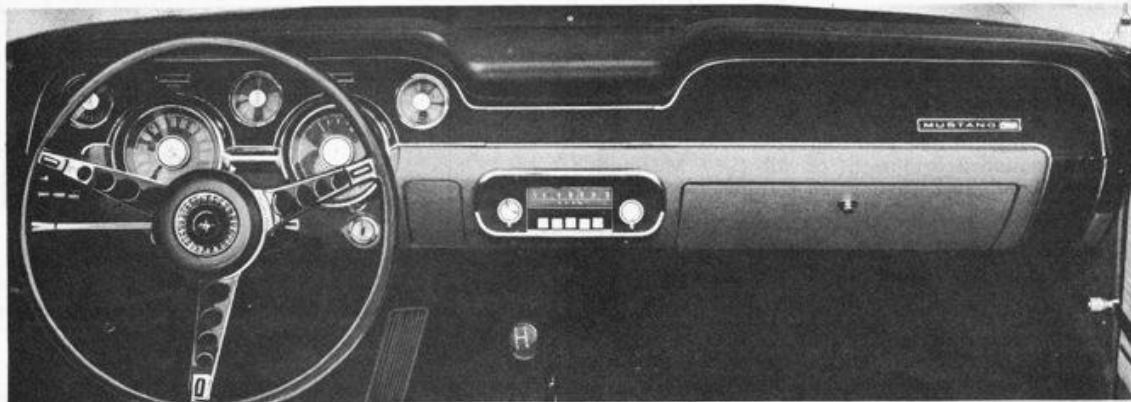

## INSTRUMENT PANEL

The instrument panel and cluster are all-new for 1967. The cluster features full instrumentation contained in two large and three small pods directly in front of the driver, recessed under a large safety padded hood.

- The 120-mph speedometer and odometer are located in the large left-hand cluster pod. The large right-hand pod contains the alternator and oil pressure gauges.
- The small left-hand pod houses the fuel gauge and the right-hand pod houses the temperature gauge. The center pod houses the optional electric clock.
- The windshield wiper switch is directly above the large

left-hand pod, and the brake system warning light is directly above the right pod.

- The heater controls are at the extreme left below the cluster. The light switch is to the left of the steering column and the four-position ignition switch is to the right.
- The left air vent control is attached to the right side of the steering column — the right vent is controlled by opening a door in the heater housing.
- The pullout ash tray with concealed cigarette lighter is directly to the right of the ignition switch. The large swing-down glove box is located at the right of the panel.
- An optional AM radio or AM Radio/StereoSonic tape system may be installed at the center of the panel.

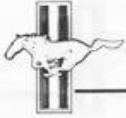

## MUSTANG FEATURES

### RIDING COMFORT

Outstanding characteristics of the Mustang since its introduction have been a smooth, comfortable ride, easy, responsive steering and excellent road handling ability. For 1967, improvements have been made in the suspension, steering and tread to further improve on these characteristics.

- **FRONT SUSPENSION** — the '67 front suspension is all-new and embodies many of the design improvements of the larger cars. Major changes include a two-and-one-half inch longer lower arm and a lower inner pivot on the upper arm. This results in a better wheel attitude under all road conditions for a smoother ride and better control.
- **WIDER TREAD** — Both the front and rear treads have been increased approximately two inches — front and rear tread are now a nominal 58 inches. This new wide stance increases roadability and driver control.
- **STEERING LINKAGE** — The steering linkage is all-new for '67 to accommodate the new suspension and tread width increase. In addition, several improvements have been made in the system design. The tie rod ball joints feature polyethylene filled sockets that have low friction characteristics, offering a significant decrease in turning efforts. The polyethylene also has excellent damping characteristics to help prevent feedback of road shock through the steering system. Other advances include a reduction in the turning diameter and a decrease in the overall steering ratio with both the manual and power systems. These changes offer better maneuverability when parking and easier, more responsive steering on the open road. (refer to page 9)

### REVERSIBLE KEYS AND KEYLESS LOCKING SYSTEM

Ford's unique design reversible keys and a keyless locking system are used on all Mustangs. The reversible keys have two identical sides and may be inserted conveniently into the lock with either side up. They are used on all locks, including the ignition switch. The keyless locking system offers extra convenience by permitting the doors to be locked by depressing the inside lock button, then holding the outside push-button in as the door is closed.

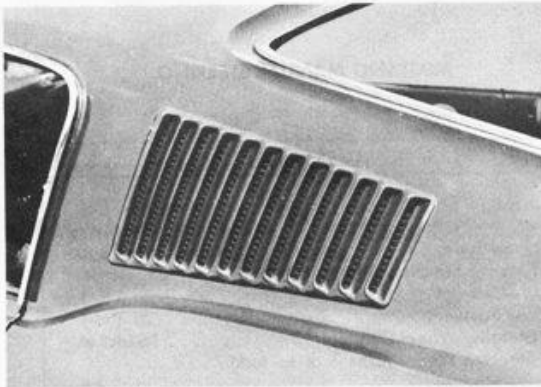

### 2 + 2 FASTBACK VENTILATION SYSTEM

Standard equipment on the 2 + 2 Fastback is a "Silent-Flo" ventilation system that incorporates functional

louvers styled into the roof rear quarters. The vents are manually controlled from the inside — from full closed to full open. With the vents and front air inlets open, and the windows closed, the speed of the car promotes quiet, fresh air circulation throughout the passenger compartment.

### STANDARD LUXURY FEATURES

The 1967 Mustang includes a host of luxury features and appointments as standard equipment, providing extra sports appeal, comfort, convenience and pride of ownership.

**FULL WHEEL COVERS** — Standard on 2 + 2 Fastback the cleanly styled wheel covers feature a radial spoke design that emphasizes the full circular wheel cutouts and sports styling of the exterior sheet-metal. The center hub is slightly depressed and contains an insert with a Mustang emblem.

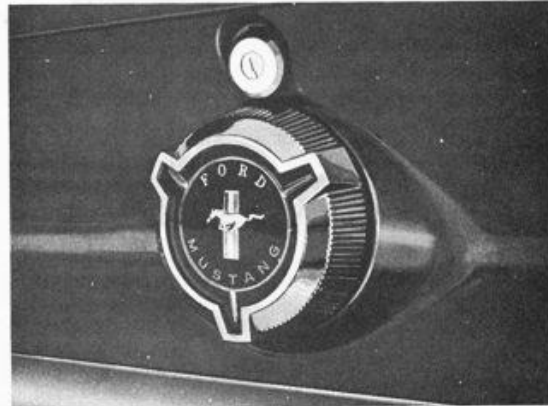

**STYLED FUEL FILLER CAP** — The convenient center located fuel filler cap features a three-blade simulated "knock-off" design that adds to the sports decor of the rear styling. The center of the cap contains a plastic insert with Ford and Mustang lettering plus the attractive red, white and blue Mustang emblem. For theft protection, the cap is attached to the body with a firmly anchored hidden cable.

### ADDITIONAL LUXURY FEATURES include —

- Nylon-rayon carpeting molded to the floor contour.
- All-vinyl upholstery in seven rich and durable colors.
- Twin front bucket seats that are sculptured and foam-padded for maximum comfort and tastefully trimmed in bright metal.
- Color-keyed all-vinyl headlining in Hardtop and 2 + 2 Fastback models.
- Gauges for fuel level, engine temperature, alternator, and oil pressure.
- Suspended accelerator pedal that gives smooth, responsive action and permits easy cleaning of the front floor area.
- Courtesy lights with door-operated switches. Hardtop has dome-light; Fastback and Convertible have under-instrument panel lights.
- 14-inch low-profile tires that offer a smooth ride and excellent stability.

# MUSTANG CHASSIS

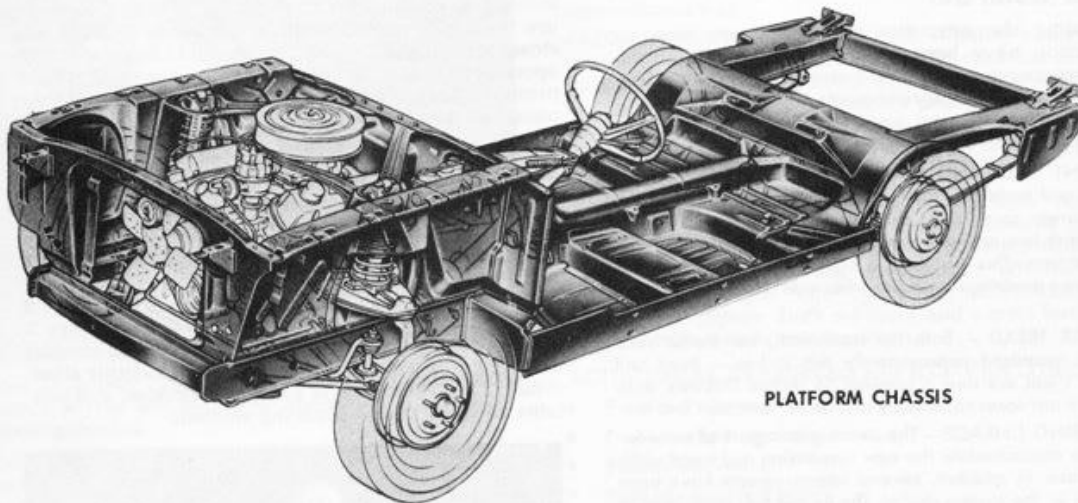

PLATFORM CHASSIS

## PLATFORM CONSTRUCTION

The platform construction of the Mustang chassis is a Ford "first" in the American mass market. Based on sound engineering principles, this type of construction has many advantages and is one of the main reasons for the smooth riding characteristics and the rattle-free body of the Mustang.

The platform carries the body on the top, encloses the engine, and provides attaching points for the various chassis components. It also provides the strong basic structure, or foundation, of the car. The platform is made up of box-section front and rear side rails tied in securely to heavy boxed-in rocker panels. These components are connected by five heavy-gauge cross-members to form an extra strong ladder-type framing under the car. The front and rear side rails extend partially under, and are welded to, the floor pan. The full-depth, full-length tunnel down the center of the floor pan adds a "backbone," giving the structure maximum rigidity. The full-depth side panels, in the engine compartment, are welded to the front side rails at the bottom and to the cowl at the rear. The tops of these panels are pressed over forming a wide flange, increasing front end rigidity. A one-piece stamping with a deep channel section at the top connects the side panels across the front.

## STEERING

The Mustang steering system is of the parallelogram linkage-type with a cross link and idler arm. The steering gear used is Ford's Magic-Circle recirculating ball-and-nut type. All new components are used to accommodate the new front suspension and increased tread width.

Incorporation of polyethylene filled sockets in all the ball joints provides lower friction characteristics and reduces overall steering effort. In addition, the polyethylene provides better damping to help reduce shock feedback through the steering system.

The manual steering ratio is 25.3 to 1, compared to the previous 27 to 1, offering faster, more responsive steering with less effort.

A faster ratio steering gear is used when either the optional competition handling package or optional power steering is installed. This gear provides an overall steering ratio of 20.3 to 1 and will turn from lock-to-lock in 3.6 turns.

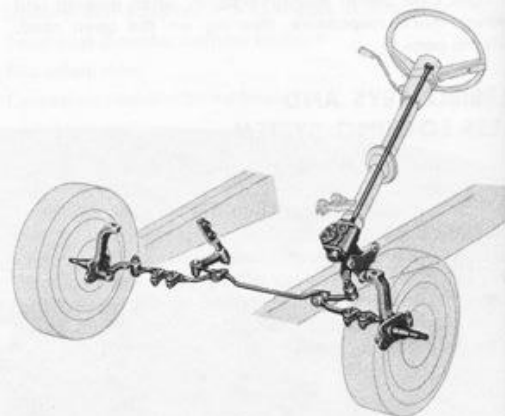

MUSTANG MANUAL STEERING

## STEERING SPECIFICATIONS

Linkage . . . . .	Parallelogram with Cross Link and Idler Arm
Gear Type . . . . .	Magic-Circle Recirculating Ball
Overall Steering Ratio	
- Manual . . . . .	25.3 to 1
- Power . . . . .	20.3 to 1
Steering Wheel Diameter . . . . .	16 inches
Steering Wheel Turns (lock-to-lock)	
- Manual . . . . .	4.6
- Power . . . . .	3.6
Turning Diameter (curb-to-curb) . . . . .	37.2 feet



# MUSTANG CHASSIS

## FRONT SUSPENSION

The '67 Mustang front suspension system is all-new and embodies many design improvements. All attaching points of the single lower arms and A-frame upper arms, to the body, are through rubber bushings to keep inherent friction to a minimum. The new lower arm is two-and-one-half inches longer and the upper A-frame arm pivot has been lowered. These two changes provide a more uniform wheel attitude on both jounce and rebound. A special service feature is the incorporation of separate cam adjustments for both camber and caster, eliminating the adjustment shims used previously. These adjustments can now be made faster, more accurately and independent of each other.

The telescopic shock absorbers are mounted inside the coil springs, and feature constant-viscosity fluid to provide more uniform damping of the suspension system under all climatic conditions.

The new lower control arm is connected to the chassis platform with a rubber-bushed control strut. Two large resilient bushings at the front of the strut permit a slight, controlled, horizontal wheel movement that helps the tires cushion small road irregularities, especially at high speeds. A rubber-bushed stabilizer bar provides effective sway control.

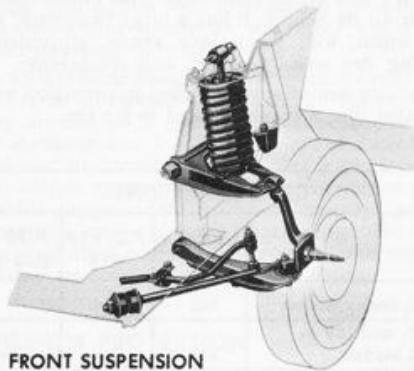

FRONT SUSPENSION

A unique option available on the Mustang is the heavy-duty suspension which includes increased rate

springs, larger and recalibrated shock absorbers, and increased diameter stabilizer bar. This option provides increased roadability and handling.

SUSPENSION SPECIFICATIONS	
<b>FRONT</b>	
Type . . . . .	Independent with Ball Joints
Springs . . . . .	Helical Coil, Rubber-Insulated
Shock Absorbers . . . . .	Hydraulic, Telescopic, Vertical-Mount
Stabilizer . . . . .	Link-Type, Rubber-Bushed
Steering Knuckle . . . . .	Integral Spindle and Spindle Support
Wheel Bearings . . . . .	Opposed Tapered Roller
<b>REAR</b>	
Type . . . . .	Variable Rate, Longitudinal Semielliptic Leaf Springs with Rubber-Bushed Hangers
Number of Leafs . . . . .	4
Leaf Length and Width . . . . .	53" x 2.5"
Spring Shackles . . . . .	Compression-Type Rubber-Bushed
Shock Absorbers . . . . .	Hydraulic, Telescopic, Angle-Mount

## REAR SUSPENSION

All Mustangs employ wide, long rear springs in the Hotchkiss-type design rear suspension. These four leaf springs effectively cushion bumps and road irregularities while absorbing the twisting action of the rear axle as it reacts to acceleration and braking forces. Special plastic liners are used at the spring tips to reduce friction and help absorb the smallest bump.

A large, resilient rubber bushing at the front mounting eye reduces road shock and noise and permits slight horizontal wheel movement which helps absorb small irregularities. At the rear, the spring is held in a rubber-bushed, compression-type shackle, allowing easy flexing on light impact and providing greater resistance to severe impact. Shock absorbers are angle-mounted to help reduce side sway to a minimum, and use constant-viscosity fluid for more uniform snubbing action in any weather.

When the optional heavy-duty suspension is installed, the rear suspension includes heavy-duty springs and shock absorbers.

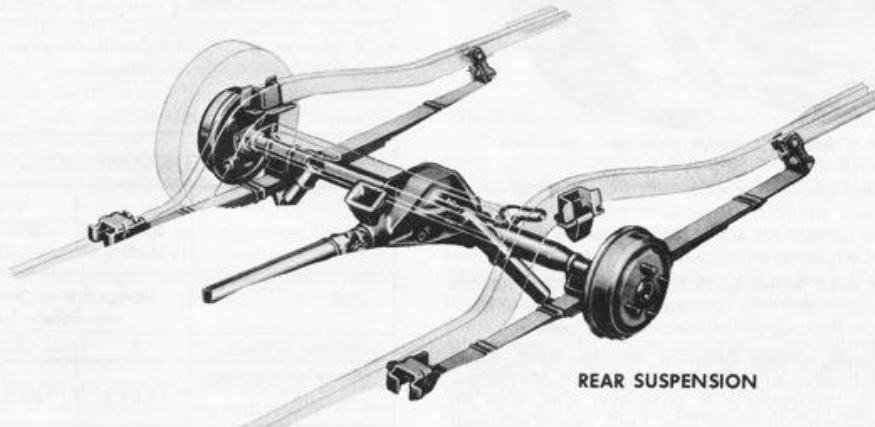

REAR SUSPENSION

# MUSTANG CHASSIS



## BRAKES

All Mustangs are equipped with a new dual hydraulic brake system. The system has a dual master cylinder operated by one foot pedal. Each of the master cylinders has its own pumping section and fluid reservoir. Separate hydraulic lines connect one master cylinder to the front brakes and one to the rear. Thus, any loss of hydraulic pressure in one-half of the system would not leave the other half of the system inoperative. If the front brakes should develop a leak, the rear brakes will still function and vice-versa.

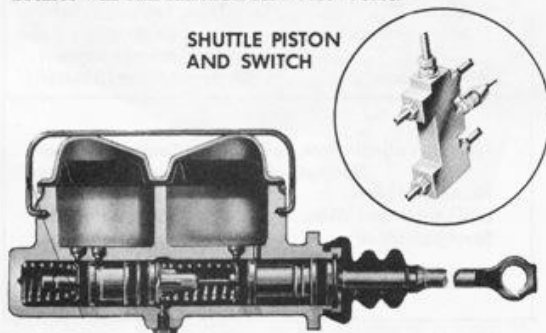

DUAL MASTER CYLINDER

As an added safety feature, an instrument panel warning light will go on if a pressure loss occurs in either half of the system. The light is connected to a shuttle piston between the front and rear brake lines. Normally, the shuttle piston does not move. But, should a pressure loss occur in either brake system, a significant differential in pressure results and the shuttle piston activates a switch that turns on the warning light when brakes are applied.

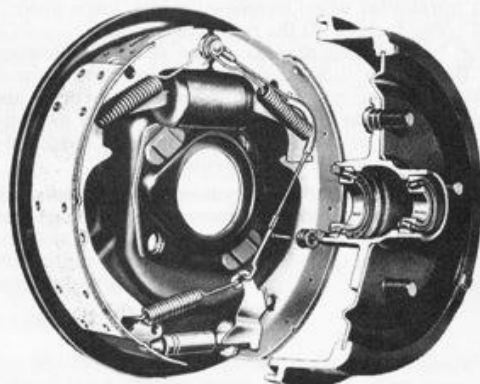

STANDARD DRUM BRAKES

The standard brakes are duo-servo design, self-energizing, single anchor, internal expanding, and air-cooled. The linings are self-adjusting when the brakes are applied while the car is moving in reverse.

Mustang's rear wheel parking brakes are operated by cables connected to a convenient twist-release handle under the left side of the instrument panel.

For unusually severe braking service, front wheel power disc brakes are offered on all V-8 Mustangs. The brakes incorporate a cast-iron disc with an oblong brake pad on either side. Each pad is actuated

## BRAKE SPECIFICATIONS

	6-Cyl.	289 V-8	390 V-8
Brake Drum Diameter	9"	10"	10"
Lining Material	Molded Asbestos		
Lining Attachment	Riveted		
Total Lining Area - Gross (Sq. In.)	131.0	154.7	163.1

by two brake cylinders, clamping the pads equally on the disc for smoother, more dependable straight line stops. The disc is a one-piece casting with radial ribs separating the two braking surfaces, permitting air to circulate in-between for maximum heat dissipation.

## TIRES AND WHEELS

All 1967 Mustangs are equipped with 14-inch wheels and 6.95 x 14 tires (7.35 x 14 with 390 V-8). The tires are low-profile design, featuring a tire shape with a wide cross-section and reduced dimension between the road and rim. Newly designed F-70-14 Wide-Oval WSW tires are optional on all V-8 models. This tire has an exceptionally wide cross-section in relation to its height. It has a large "footprint" on the road which, with the unique shape, provides outstanding tire wear, traction, and roadability.

The wheels are of stamped steel construction with the ventilated disc securely welded to the rim.

## TIRE SPECIFICATIONS

	6.95 x 14 4 PR	7.35 x 14 4 PR	F-70-14 Wide-Oval
Six-Cylinder Models	Std.	Opt.	-
289 2v and 289 4v V-8 Models	Std.	Opt.	Opt.
289 High-Perf. V-8	Std.	Opt.	Opt.
390 4v V-8	-	-	Std.
All Models with GT Equipment Group	-	-	Std.

F-70-14 tires are white sidewall. All other tires are black sidewall with white sidewall optional.

## WHEEL SPECIFICATIONS

	6-Cyl. Models	V-8 Models	
		289 2v & 4v	390 4v
Type	Stamped Steel Ventilated Disc with Safety-Type Rims		
Number of Studs	4	5	5
Diameter and Rim Size (In.)	14 x 4.5	14 x 5	14 x 6



## MUSTANG BODIES

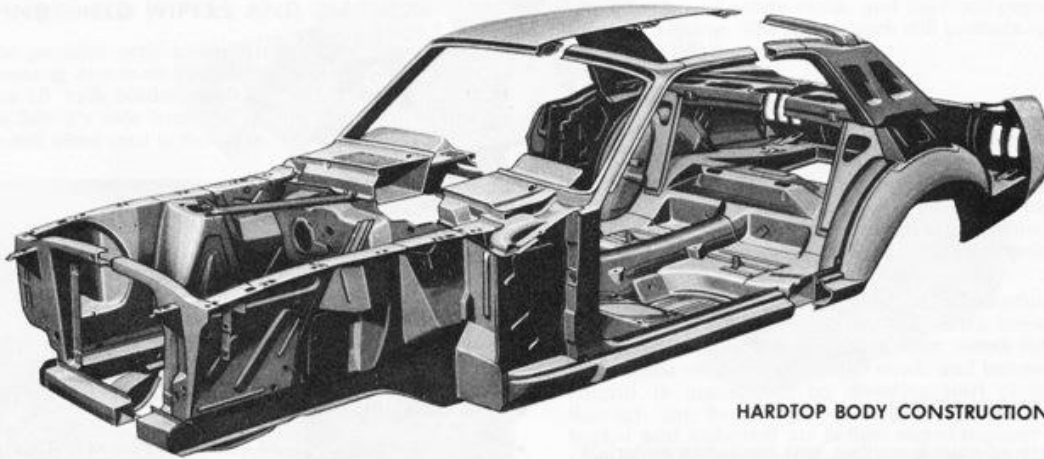

HARDTOP BODY CONSTRUCTION

### BODY CONSTRUCTION

The Mustang all-welded body assembly is designed and engineered to provide maximum strength with minimum weight. The body is welded to the platform-type chassis giving maximum durability and a solid feel when traveling on rough roads.

Except for the basic design differences in the roof area, the bodies of all models are essentially the same. All framing around body openings and the roof bracing on the Hardtop and 2 + 2 models are of either box-, channel- or hat-section design. The high strength, double-walled upper cowl and the instrument panel are welded integral with the body structure, adding extra rigidity and resistance to twisting. The front fenders are bolted on for easy removal and replacement if ever required.

### CORROSION PROTECTION

The Mustang body has been carefully protected to retard rusting from corrosive elements and moisture. Interior body areas are vented to help prevent the entrapment of moisture. Zinclad steel is used for the body and platform members where maximum protection is required. This is standard steel to which a heavy coating of molten zinc is applied. In all, over 20 pieces of the body and platform are of Zinclad steel. Included are the front and rear side rails, rocker panels and the body panels beneath the front and rear bumpers. In addition, zinc-rich primer is applied to lower interior portions of the various body panels, doors, pillars, and to the splash areas of the wheel-housings.

Asphalt-base sound deadener is sprayed on the various body and platform panels such as doors, quarter panels and wheel-housings, providing further corrosion protection.

### CONVERTIBLE TOP

The standard top on the Mustang Convertible is manually operated. It is specially designed and with the

assistance of the counterbalance springs, located in cylinders attached to the floor pan, raises and lowers easily. The five-ply vinyl and cotton top material is firmly attached to the roof mechanism, preventing unsightly "ballooning" at highway speeds. The top is available in either black or white with any exterior color and a stretch-vinyl boot, color-keyed to the interior trim, can be snapped in place over the folded top. An electro-hydraulic power top and an "all-glass" rear window are optional.

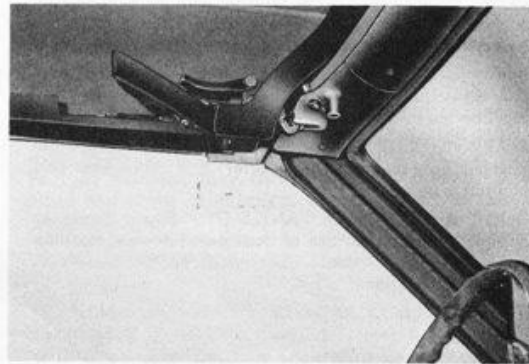

CONVERTIBLE TOP LATCH

The latches anchoring the convertible top feature a high leverage ratio for quick, low-effort operation. They are located on the side rails to prevent interference with the sun visors, and are flush when in the locked position.

As an extra quality feature, a variety of top adjustments are provided on the Mustang Convertible. These allow the top mechanism to be adjusted for a precise fit, permitting easier raising and lowering, draft-free operation in the winter, and a taut, neat appearance of the top material. Top adjustments are provided at the main pivot bracket attachment, center side rail, top header, side rail weatherstripping, No. 2 bow, header dowel pin, and latch toggle clamp.

# MUSTANG BODIES

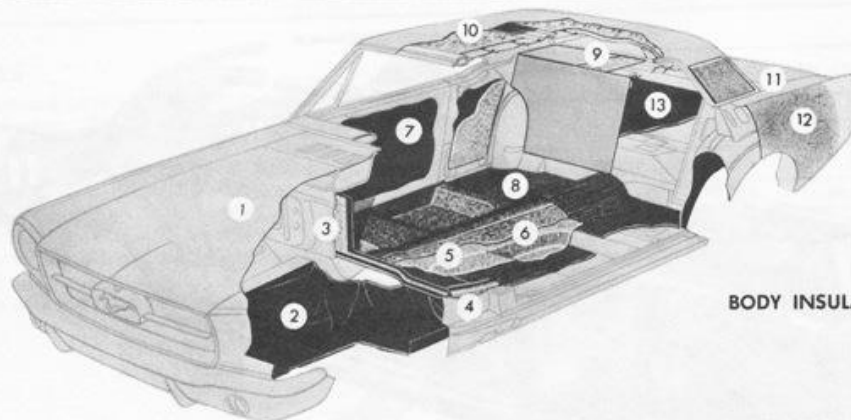

**BODY INSULATION**

## BODY INSULATION

A variety of soundproofing and insulating materials surround the passenger compartment of all Mustangs. This enables driver and passengers to enjoy to the fullest the smooth ride and comfortable interior. The materials are carefully selected to shield occupants from engine and road noise, and provide protection against weather extremes.

- **HOOD (1)** – Inner- and outer-panel construction. Mastic adhesive spotted between panels.
- **FRONT FENDERS (2)** – Inner housing, including fender apron, sprayed with sound-deadener coating.
- **DASH PANEL (3)** – One-inch thick molded textile-fiber pad between passengers and engine with heavy plastic (vinyl) coating.
- **COWL SIDES (4)** – One-quarter-inch thick fiberglass pads at cowl sides.
- **FRONT FLOOR AREA (5)** – Toeboard to back of front seat has extra-heavy rubberized asphalt mat sound deadener plus thick jute pad and one-quarter-inch textile-fiber pad bonded to floor mat.
- **REAR FLOOR AREA (6)** – Heavy rubberized asphalt mat plus thick jute pad and one-quarter-inch textile-fiber pad bonded to floor mat.
- **DOOR AND QUARTER PANELS (7)** – Sound deadener applied to inner surface of door outer panels. Hardtop has one-half-inch textile-fiber pad bonded to inner surface of quarter panel.
- **REAR SEAT AREA (8)** – Heavy rubberized asphalt mat from front of seat to back of axle kick-up. Hardtop has seat back covered with one-half-inch thick textile-fiber padding.
- **PACKAGE TRAY (9)** – Hardtop has one-quarter-inch textile-fiber padding under full width of package tray covering.
- **ROOF PANEL (10)** – One-half-inch thick fiberglass blanket insulates entire roof panel front to rear. Hardtop and Fastback only.
- **DECK LID (11)** – Inner- and outer-panel construction. Mastic adhesive spotted between panels.
- **REAR WHEELHOUSING (12)** – Splash areas are sprayed with sound deadener. Cellulose pads between wheel-housings and quarter panels for extra quietness.
- **LUGGAGE COMPARTMENT (13)** – Floor area covered with rubber mat. Fastback and Convertible have one-half-inch textile-fiber pad bonded to top of gas tank.

## BODY SEALING MATERIALS

- **JOINT SEALERS** – Exposed spot-welded seams and joints are protected by special plastic sealing material. Vinyl plastic sealing compound is used at roof drip rails and rear deck trough. Heat-curing sealer material is applied full length to all other panel seams and joints.
- **SPECIAL ANTISQUEAK AND SEALING DEVICES** – Special pads, grommets, seals and plug buttons guard against friction, water, dust and drafts. Windshields and rear window are sealed with a special nondrying plastic compound that retains its elasticity and keeps a tight seal. Plastic shields cover inside surfaces of door trim panels to prevent water damage.

## WINDOWS

All glass in the 1967 Mustang meets or exceeds the safety requirements of the American Standards Association and the motor vehicle safety regulations of the individual states. The laminate, or inner layer, of the windshield is a thicker, more pliable substance, with a much looser bond. These features allow the windshield to take considerably more impact without penetration. All back and side windows are solid tempered glass, except for the Convertible rear window which is clear, all-vinyl. Tinting is standard on the large rear window of the 2 + 2 Fastback model. Mustang's curved side glass blends the roofline into the body side panels, and the quarter panel windows are fully retractable for a trim appearance in the "windows down" position.

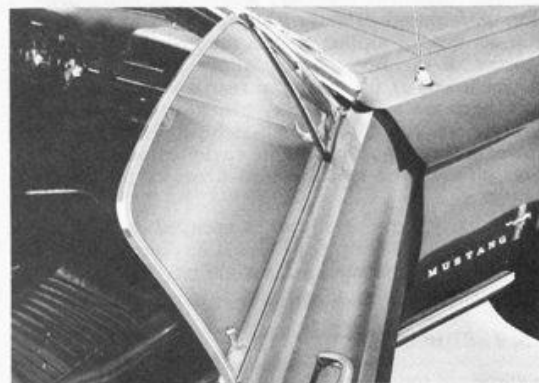

**CURVED SIDE GLASS**



## MUSTANG BODIES

### WINDSHIELD WIPERS AND WASHERS

The parallel-action, electric-powered wipers on the Mustang create an excellent windshield wiper pattern. The 15-inch blades reach far into the corner area at the driver's side front pillar, helping to eliminate the typical blind spot in this area.

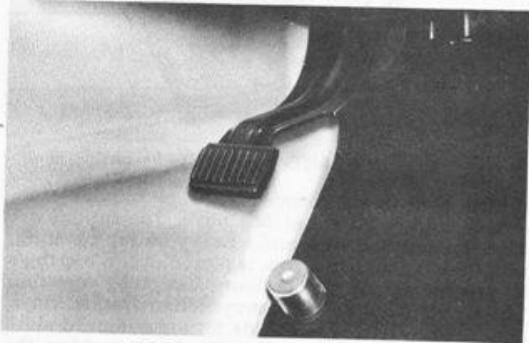

FOOT-OPERATED WASHERS

Two-speed wipers and washers are standard on all 1967 Mustangs. The windshield washer is the extra convenient, foot-operated type. When washer operation is required, the driver merely pushes the pedal with his left foot, forcing twin streams of fluid on the windshield. This feature permits the driver to keep both hands on the wheel and his eyes on the road.

### HOOD

The Mustang hood is of double-panel construction with the inner panel formed into bracing to add to overall strength and rigidity. Inner and outer panels are welded around the outside, and bracing is bonded to the outer panel with a special mastic. Easy opening and closing is permitted by the counterbalanced, double-link hinges. Rubber bumpers around the outer edge prevents squeaks and rattles. The two front bumpers are adjustable for alignment purposes.

The single-action hood release lever, located under the hood lip at the top of the grille, releases both the

hood latch and safety catch, and the hood pops open for easy raising. The safety catch still protects against accidental hood opening.

### HEATING AND VENTILATION

A high capacity heater that can maintain comfortable passenger compartment temperatures even in below-zero weather is standard equipment on all Mustangs. The heater incorporates defroster ducts that direct a high volume of heated air through registers on either side of the radio speaker grille at the top of the instrument panel.

The 195-degree thermostat used on all Mustang engines provides faster warm-up and extra heater capacity. All air for the heating system enters through the outside vent on top of the cowl, and temperature control is maintained by directing part of the air through the heater core and part around it. The heated and unheated air is then mixed together in the plenum chamber and directed out the defroster for efficient windshield defogging. When extra defogging is required, moving the defroster lever to "Defrost" directs all the heater output through the defroster. The blower is ordinarily used only to speed up the heat output or to maintain the interior temperature in slow-moving traffic. At moderate to fast road speeds sufficient air is forced into the system to maintain comfortable passenger compartment temperature.

Two fresh air inlets, one each on the right and left side, can be opened to provide fresh air ventilation. The right side vent is controlled by opening a door on the heater housing, while the left side inlet is controlled by a knob under the left side of the instrument panel. On the 2 + 2 Fastback, a "Silent-Flo" ventilation system is used in conjunction with the front air inlets, and features manually operated vents on the roof rear quarters. The vents are designed to draw out stale air and smoke and assist in defogging the rear window. In moderate weather, the vents can be fully opened with the windows closed to reduce wind noise, keep out rain and dust, and provide quiet air circulation throughout the passenger compartment. In cold weather, they can be partially opened to promote increased circulation of heated air to the rear compartment.

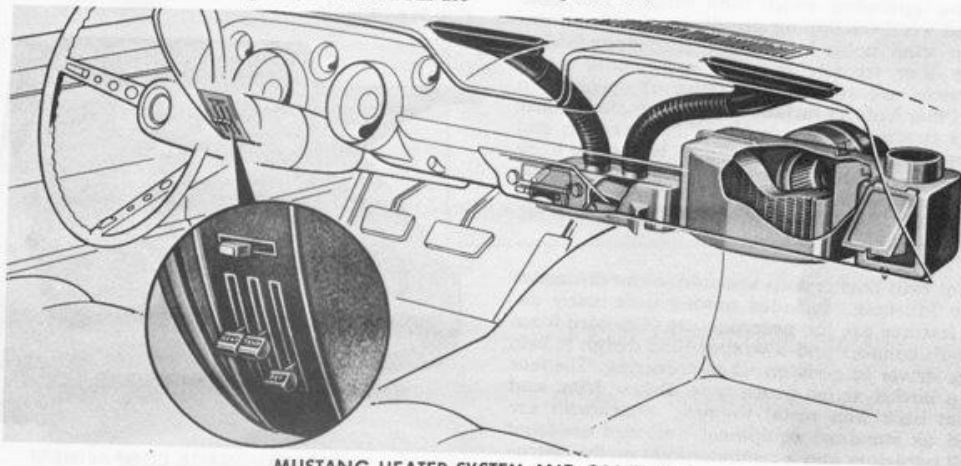

MUSTANG HEATER SYSTEM AND CONTROLS

# MUSTANG BODIES



## DOORS

The Mustang doors are extra long and wide opening to permit easy entrance and exit to both front and rear seats. The doors are of double-panel welded construction with double-lap outer edges.

The upper, lower and rear portions of the door inner panel also serve as door moldings and are color-keyed to the interior trim selection with low-gloss enamel. The all-vinyl door trim panel is accented with bright moldings. The standard arm rests have special built-in energy-absorbing properties in a lateral plane, yet provide firm vertical arm support. (refer to page 6) The trim panel used with the Interior Decor Option features molded construction with an integral arm rest and door closing handgrip.

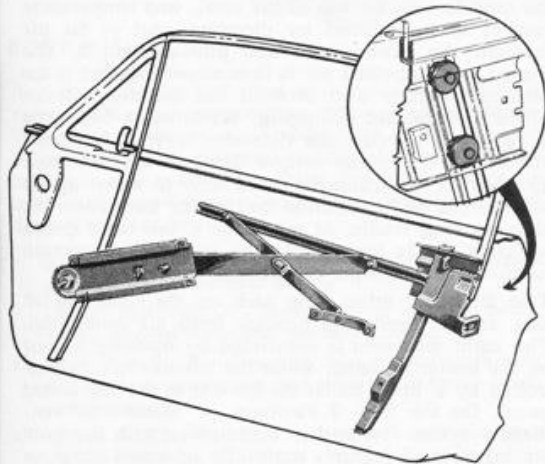

WINDOW REGULATOR AND GUIDE

A new door window regulator system and nylon roller guide in the rear glass channel provides smoother, more consistent operation and increases Mustang's window stability in all opening positions. The regulator system has two less pivot points than previously, providing an overall decrease in friction that results in approximately a 25 percent reduction in window operating effort. New window and door seals and weatherstripping provide a significant decrease in wind noise level. Bear-Hug door latches hold the door securely in position for more rattle-free service, and reduce the chance of opening on impact. Other features include oil-impregnated bronze bushings in the hinges for long-life operation and easier opening and closing, and a two-stage door check that holds the door in either the full open or partially open position.

## SEATS

The front twin bucket seats are unique and distinctive with the Mustang. Included among their many desirable features are the generous use of molded foam for superb comfort and a wraparound design to help hold the driver in position when cornering. The rear seat is a bucket-styled bench type. Deluxe front and rear seat belts with metal-to-metal attachment are installed as standard equipment. Included are front seat belt retractors and a reminder light on the instrument panel.



MUSTANG BUCKET SEAT

Bucket seat frame members are of tubular steel, formed and welded into one piece. The springs are of preformed steel wire, and a heavy burlap covering, with interwoven steel wires, is placed over the springs to prevent damaging the foam cushioning material. The seat is covered with heavy, cotton-backed vinyl, and bright-metal side shields on the outboard sides of the cushion and seat back. For extra comfort, the seat cushion and back insert areas feature foam-filled pleated construction. The seats used with the Interior Decor Option are pleated with a bright-metal molding around seat and seat back. A bright ornament decorates the center of the seat back. In addition, attractive, high-strength molded plastic is used on the back of the decor bucket seat.

Both front seats are solidly attached to sturdy roller bearing seat tracks that are fully adjustable through five inches of travel. The seat tracks have low-friction nylon slides and built-in assist springs for easy seat adjustment.

## LUGGAGE COMPARTMENT

The luggage compartment floor in all Mustangs is covered with an attractive patterned rubber mat. The Hardtop luggage compartment has a usable capacity of 9.2 cubic feet, with 7.7 cubic feet in the Convertible. In '67, the 2 + 2 Fastback model will have a fixed partition at the front of the luggage compartment and a usable capacity of 5.1 cubic feet. A Sport Deck Option is available.



HARDTOP LUGGAGE COMPARTMENT



# MUSTANG BODIES

## BODY SPECIFICATIONS

All dimensions are in inches unless otherwise specified.	Hardtop	Convertible	2 - 2 Fastback
<b>GENERAL</b>			
Wheelbase	108	108	108
Tread - Front (6 - Cyl.)	57.9	57.9	57.9
- Front (V-8)	58.1	58.1	58.1
- Rear (6 - Cyl.)	57.9	57.9	57.9
- Rear (V-8)	58.1	58.1	58.1
Height - Overall	51.6	51.6	51.8
Width - Overall	70.9	70.9	70.9
Length - Overall	183.6	183.6	183.6
<b>ENTRANCE ROOM</b>			
Door Opening Width	55.0	55.0	55.0
Door Opening Height (scuff plate to windcord)	31.6	31.2	31.5
Foot Clearance - Front	14.5	14.5	14.5
Entrance Height (seat to windcord)	29.2	28.7	29.0
<b>FRONT SEAT ROOM</b>			
Head Room (effective)	37.4	37.8	37.3
Maximum Leg Room to Accelerator	41.8	41.8	41.8
Hip Room	53.9	53.9	53.9
Shoulder Room	53.4	53.4	53.4
Cushion Height (from floor to crest at front)	9.2	9.2	9.2
Cushion Depth	17.1	17.1	17.1
Steering Wheel to Cushion Clearance	6.2	6.2	6.2
<b>REAR SEAT ROOM</b>			
Head Room (effective)	35.9	35.9	*
Minimum Leg Room	28.8	28.8	*
Hip Room	50.9	43.5	*
Shoulder Room	53.9	43.5	*
Cushion Height (from floor to crest at front)	11.1	11.1	*
Cushion Depth	15.2	15.2	*
<b>LUGGAGE CAPACITY (CU. FT.)</b>			
Usable Luggage Capacity	9.2	7.7	5.1
<b>GLASS AREA (SQ. IN.)</b>			
Side Glass Exposed Surface Area	1073.0	1039.8	913.6
Windshield Exposed Surface Area	1070.4	1070.4	1070.4
Backlight Exposed Surface Area	803.0	513.2	1453.6
Total Glass Exposed Surface Area	2946.4	2623.4	3437.6

\* Not applicable

# MUSTANG OPTIONS AND ACCESSORIES



## NEW AND IMPROVED OPTIONS

Since its introduction, Mustang has been described as "the car designed to be designed by you." This is made possible by the many options that enable it to take on any level of luxury, comfort, performance, or sports appeal — whatever the preference of the individual owner. For 1967, the option availability has been expanded and refined.

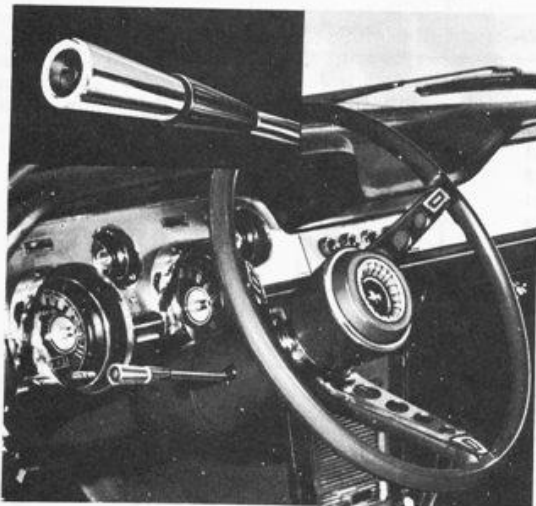

**FINGERTIP SPEED CONTROL** — A new convenience option is the speed control system, designed into the turn signal lever. Operation is simple, the driver accelerates the car to any speed between 25 and 80 mph, turns the speed control switch on the instrument panel to the "On" position, and pushes the "Set" speed button on the end of the turn signal. The system takes over at this point and maintains the car speed. If a higher speed is desired, the driver merely accelerates and then re-energizes the "Set" speed button. Or, he can hold the button down, and the car will slowly accelerate until the button is released. If the driver has de-energized the speed control by application of the brake, he can return to the previously set speed by rotating the "Resume" sleeve on the end of the lever.

**TACHOMETER AND TRIP ODOMETER** — The tachometer and trip odometer is a new Mustang option for the motoring enthusiast. The large easy reading 0 to 6000 rpm (0 to 8000 rpm with 289 High-Perf. V-8) tachometer is located in the right-hand instrument cluster pod. The trip odometer is integrated with the speedometer and features an easy action push-button reset button that quickly and easily returns the odometer to zero. When this option is installed, the standard equipment oil pressure and alternator gauges are replaced by lights at the bottom of the tachometer.

**TILT-AWAY STEERING COLUMN** — A new Ford Motor Company development for 1967, the Tilt-Away steering column offers extra driving comfort and convenience. By merely pushing the turn signal lever forward the wheel can be moved to any of nine tilt positions. Releasing the lever locks the wheel in the selected position. The swing feature is automatic. With the car and engine stopped, and the

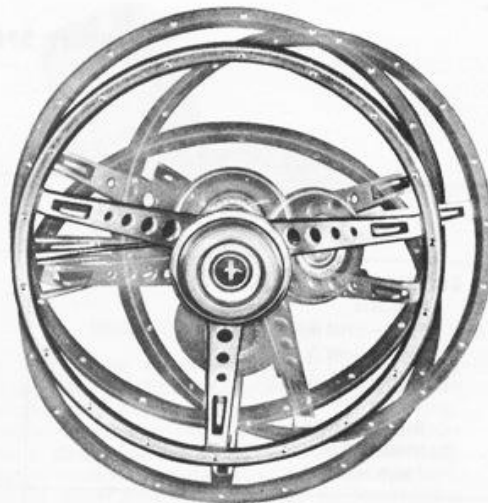

shift lever in "Park," opening the driver's door swings the column up and to the right at a 45-degree angle, providing maximum entry/exit room. After re-entering, and with the door closed, the driver pulls the column back and it locks in position. A built-in "memory" always returns the wheel to the previously adjusted tilt position.



**CONVENIENCE PANEL** — Available for the first time on the '67 Mustang is the convenience panel that includes warning or reminder lights for door ajar, parking brake, low fuel and seat belts. The panel is installed on the instrument panel above the radio or on the optional console.

**GT EQUIPMENT GROUP** — The GT Equipment Group provides all the components for outstanding performance, with an exterior appearance that is unmistakably GT. Included are bright beam fog lamps, power assisted front disc-rear drum brakes, narrow/wide/narrow racing stripes full length and low along each side with a GT plaque at the front, F-70-14 Wide-Oval WSW tires, and a heavy-duty suspension that includes stiffer springs, larger shock absorbers and a larger front stabilizer bar. In addition, with the 390 or the 289 High-Perf. engines, a low restriction dual exhaust with bright-plated "quad" exhaust extensions is included.

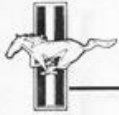

## MUSTANG OPTIONS AND ACCESSORIES

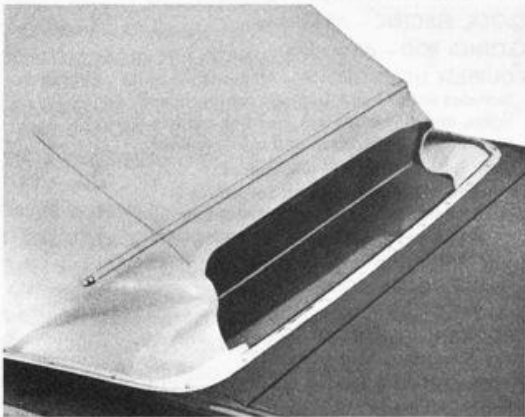
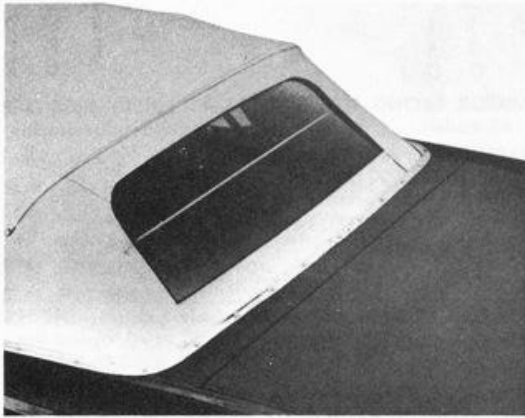

**CONVERTIBLE ALL-GLASS REAR WINDOW** — The all-glass rear window is available as an option on the 1967 Mustang Convertible. This represents a significant technical achievement, because of the limited space in the well behind the rear seat, insufficient to hold a large window. It has been accomplished by using a split rear window hinged horizontally with a strip of translucent rubber. The rubber hinge is a special silicone compound that resists aging, discoloration and cracking.

When the top is down, the window folds at the hinge line to store neatly below the convertible stack in the well. With the top up, the window has all the advantages of Sedan and Hardtop rear windows — resistance to scratching and discoloration and less distortion.

**EXTERIOR DECOR GROUP** — A new option, the Exterior Decor Group accentuates the sporty styling appeal of the basic Mustang. Included are hood louvers with integral turn signal lights visible to the driver, bright-metal molding around the wheel openings, and a fuel filler cap that pops open at the touch of a button. It also includes rear deck and quarter panel moldings on Hardtop and Convertible.

**INTERIOR DECOR OPTION** — A revised option for the 1967 Mustang, the Interior Decor Option adds a



variety of elegant touches for interior luxury, rich appearance and increased safety. Included are molded door trim panels with integral arm rests, a smart horizontal theme grille on the lower door panels, a dual courtesy/rear warning lamp in the door panels, a molded roof console with two map lights (except Convertible), bright-metal trim on the foot pedals, attractive brushed aluminum appliques on the instrument panel and doors, and an electric clock in the instrument panel.

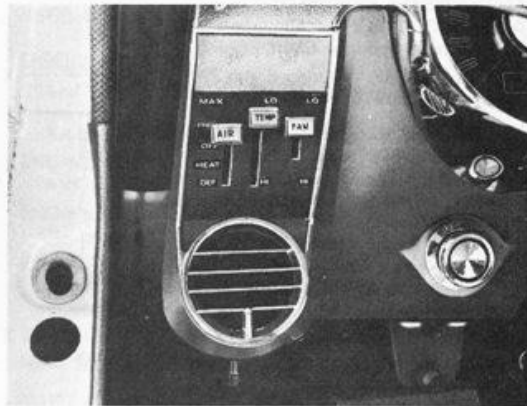

**SELECTAIRE AIR CONDITIONER** — The Select-Aire air conditioner is a deluxe unit fully integrated into the instrument panel and heating system. It is designed to provide year-round passenger comfort, obtained from one set of controls.

Four air conditioning registers are provided in the instrument panel, one at each end and two in the center. They are fully adjustable to obtain the most comfortable air distribution. For additional versatility, the unit features a three-speed blower and two air conditioning positions — a "Max Cool" (recirculating) and "Fresh" (fresh air). The reheat principle of air temperature regulation used in both positions results in maximum dehumidification and air circulation.

# MUSTANG OPTIONS AND ACCESSORIES



## COMPLETE OPTION AND ACCESSORY AVAILABILITY

In the following list, availability of the various items is designated by RPO (Regular Production Options), LPO (Limited Production Options), or DLR (Dealer Installed Accessories).

	R P O	L P O	D L R
ENGINE OPTIONS — All models (See Power Team Selection Chart, page 4)	X		
TRANSMISSION OPTIONS — All models (See Power Team Selection Chart, page 4)	X		
TIRE OPTIONS — All models (See Tire Chart on page 11 for applications)	X	X	
<b>POWER ASSISTS</b>			
POWER DISC BRAKES — All models with V-8 engines	X		
POWER BRAKES — All models			X
POWER STEERING — All models except with 289 High-Perf. V-8	X		X
POWER TOP — Convertible	X		
<b>PERFORMANCE EQUIPMENT</b>			
AXLE RATIO OPTIONS — All models (See Power Team Selection Chart, page 4)	X		
BATTERY, 55 AMP. — Standard with 390 V-8 with Cruise-O-Matic	X		X
COMPETITION HANDLING PACKAGE — Ford 390 and 289 High-Performance V-8's with GT Equipment Group. Includes extra stiff front and rear springs, adjustable shock absorbers, extra heavy stabilizer bar, 16 to 1 ratio steering gear, high ratio rear axle with unique wheel covers, 6" rims, and 6.50/6.70 x 15 sports car 200 nylon tires.		X	
ENGINE GAUGE KIT — All models			X
EXTRA-COOLING PACKAGE — All engines. Standard with SelectAire.	X		
GT EQUIPMENT GROUP — All models with V-8 engines. Includes fog lamps, special ornamentation, power disc brakes, F-70-14 Wide-Oval WSW tires, H. D. Suspension, and GT Stripes — plus dual exhaust system with bright "quad" extensions on 390 and 289 High-Performance V-8.	X		
HEAVY-DUTY SUSPENSION — All models with V-8 engines. Includes increased rate front and rear springs, larger front and rear shock absorbers and larger diameter front stabilizer bar. (Std. with GT Equipment Group)	X		
LIMITED-SLIP DIFFERENTIAL — All models with V-8 engines	X		
MIRROR, RACING-TYPE, EXTERIOR — All models			X
TACHOMETER AND TRIP ODOMETER — All models (6000 rpm except 8000 rpm with 289 High-Performance V-8)	X		
WHEELS, STYLED STEEL, 14" — All models with V-8 engines	X		
<b>COMFORT/CONVENIENCE EQUIPMENT</b>			
AIR CONDITIONER, FORD — All models			X
AIR CONDITIONER, SELECTAIRE — All models (N.A. with High-Perf. V-8)	X		
ARM RESTS, REAR — Hardtop			X
CIGARETTE LITE-LIGHTER — All models			X
CLOCK, ELECTRIC — All models	X		X
CLOTHES ROD — All models			X
COURTESY LIGHT GROUP — All models. Includes under hood, luggage compartment lights, and glove box lock. Hardtop models also include under dash and courtesy-light.	X		
CONVENIENCE PANEL — Requires console when ordered with SelectAire — All models. Includes door ajar warning light, parking brakes light, low fuel warning light and seat belt light.	X		
DOOR STORAGE COMPARTMENT — All models			X
FIRE EXTINGUISHER — 2-3/4 or 5-pound dry chemical — All models			X
FLOOR MATS — Rubber or vinyl — Front or Rear — All models			X
GLASS BACKLIGHT — Folding — Convertible	X		
GLASS, TINTED, ALL WINDOWS — All models	X		
HEAD REST KIT — All models			X
LAMP, UTILITY PORTABLE — All models			X
LIGHT, ENGINE/TRUNK COMPARTMENT — All models			X
LIGHT, PARKING BRAKE WARNING — All models			X
LIGHT, REAR SEAT — Hardtop and Convertible			X
LITTER BASKET — All models			X
LUGGAGE RACK KIT, REAR DECK MOUNT — Hardtop and Convertible	X		X
MIRRORS — All models — — RIGHT-HAND, REMOTE — To match L.H. remote mirror — TRAILER TOWING			X
RADIO, AM, PUSH-BUTTON (Antenna included) — All models	X		
RADIO, AM/FM, PUSH-BUTTON (Antenna included) — All models	X		X
RADIOS AND ANTENNAS — TWO-WAY CITIZEN'S BAND — All models			X
RADIO SPEAKER, REAR, CONVENTIONAL AND STUDIOSONIC — Hardtop			X
SEAT, CHILD SAFETY — All models			X



# MUSTANG OPTIONS AND ACCESSORIES

	R P O	L P O	D L R		R P O	L P O	D L R
SEAT BELTS, DELUXE – Push button release with reminder light – all models	X			GRILLE, LOWER BACK PANEL – All models (Available only with Exterior Decor Group at extra cost)	X		
SEAT BELT, FOR 3RD PASSENGER – All models	X		X	ILLUMINATED MUSTANG GRILLE EMBLEM – All models			X
SEAT BELT, SHOULDER HARNESS, Front – All models. (Requires deluxe seat belts)	X			INTERIOR DECOR OPTION – All models. Includes molded door trim panels, padded quarter trim panels (Hardtop only), courtesy/warning light in doors, grille on door lower panels, roof console with map lights (Hardtop and Fastback), bright trim on foot pedals, brushed aluminum instrument panel appliques, vinyl covered "T" shift lever, bright buttons in seat backs, special ornamentation, and electric clock.	X		
SEAT CUSHION, VENTILATED – All models			X	MOLDING, ROCKER PANEL – (Std. on 2 + 2 Fastback)		X	
SEAT, FULL-WIDTH WITH CENTER ARM REST, FRONT – Hardtop and Convertible (N.A. with Interior Decor Group)	X			PAINT, TWO-TONE – All models. Lower back panel dark grey only.	X		
SEAT, SPORT DECK OPTION, REAR – Fastback model only	X			PROTECTION GROUP – Color-keyed floor mats (front and rear), door edge guards, and license plate frames (front and rear).	X		X
SPEED CONTROL, FINGERTIP – V-8 engine and Cruise-O-Matic required	X		X	TONNEAU COVER – Convertible			
SPOTLIGHT – All models			X	VINYL ROOF – Hardtop (black or pastel parchment)	X		
STEREOSONIC TAPE SYSTEM (AM radio required) – All models	X		X	WHEEL COVERS, WIRE – All models	X		
TELEVISION 9-INCH, WITH ANTENNA AND HANGING BRACKET – All models			X	WHEEL COVERS – (Std. on 2 + 2 Fastback)	X		
TILT-AWAY STEERING COLUMN – All models	X			WHEEL TRIM RINGS – All models			X
TISSUE DISPENSER – All models			X	<b>SPECIAL EQUIPMENT</b>			
TRUNK RELEASE, REMOTE – All models			X	CRANKCASE EMISSION SYSTEM – Closed-type – All models (Requires exhaust emission control system)	X		
TURN SIGNALS, FENDER-MOUNTED – All models			X	ENGINE COOLANT HEATER, EXTERNAL TANK – All models			X
VACUUM CLEANER, 12-VOLT – All models			X	ENGINE COOLANT HEATER, PLUG-TYPE – All models			X
VEST, CHILD SAFETY – All models			X	EXHAUST EMISSION CONTROL SYSTEM – All models (Requires closed crankcase emission system)	X		
VINYL TRIM, VENTILATED (COMFORT-WEAVE) – Hardtop and Fastback (N.A. with full-width/arm rest front seat)	X			RADIATOR INSECT SCREEN – All models			X
<b>APPEARANCE EQUIPMENT</b>				TOOL KIT – All models			X
ACCENT STRIPE – All models	X			<b>DELETE OPTIONS</b>			
AIR HORNS – All models			X	HEATER, FRESH AIR – All models (Delete option except with SelectAire)		X	
CONSOLE – All models (Requires Radio)	X						
COVER PLATE, CONSOLE – All models			X				
DELUXE STEERING WHEEL – All models	X						
DOOR EDGE GUARDS – All models			X				
EXTERIOR DECOR GROUP – All models. Includes pop open fuel filler cap, louvered hood with turn signals, wheel opening moldings, rear deck and quarter panel moldings, on Hardtop and Convertible	X						
FRAME, LICENSE PLATE – All models			X				

# FORD ENGINES

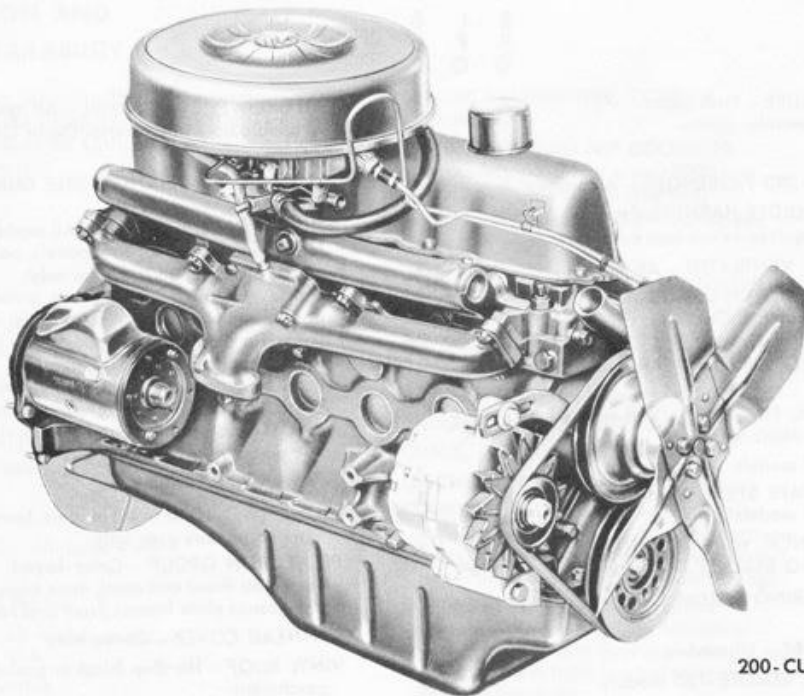

200-CUBIC-INCH SIX

## GENERAL SPECIFICATIONS

Type . . . . .	6-cylinder, in-line, overhead valve
Displacement (cubic inches) . . . . .	200
Bore and Stroke (inches) . . . . .	3.68 x 3.13
Compression Ratio . . . . .	9.2 to 1
Brake Horsepower . . . . .	120 at 4400 rpm
Maximum Torque (lbs.-ft.) . . . . .	190 at 2400 rpm
Main Bearings (number) . . . . .	7
Valve Lifters . . . . .	Hydraulic
Carburetor . . . . .	Automatic choke, single-venturi
Fuel . . . . .	Regular

## 200-CUBIC-INCH SIX

This engine is standard equipment on:

- Fairlanes, except GT and GT/A models
- Mustangs
- Falcon Station Wagons
- Falcon Futuras

It is optional equipment on:

- Falcon Club Coupes and Sedans

This exceptional six-cylinder engine has been further refined for 1967 to give greater efficiency, better low speed operation and continued good cold starting characteristics.

The seven main bearing crankshaft has been an outstanding feature of the engine that is retained for 1967. The use of seven main bearings provides extra-smooth operation and long-life durability.

Hydraulic valve lifters insure quiet, low maintenance operation of the oversize valves. The automatic choke is the dual sensing type which minimizes the chances of flooding a semi-warm engine.

## QUICK FACTS

- SEVEN MAIN BEARINGS . . .**  
Smoother engine operation. Less vibration. Longer engine life.
- HYDRAULIC VALVE LIFTERS . . .**  
Quiet operation. Low maintenance.
- LARGE VALVES . . .**  
More efficient breathing. More seat area for better cooling and less burning.
- SHORT STROKE DESIGN . . .**  
Less vibration. Less wear.
- SINGLE-VENTURI CARBURETOR . . .**  
Economical operation.
- 6000-MILE OR 6-MONTH OIL FILTER . . .**  
Reduced maintenance and improved oil filtering.
- AUTOMATIC CHOKE . . .**  
Senses ambient and coolant temperatures. Helps prevent flooding on semi-warm starts.
- 9.2 TO 1 COMPRESSION RATIO . . .**  
Better efficiency on regular or economy gasolines.
- THIN-WALL CASTING . . .**  
Better cooling. Less weight.
- PRECISION MOLDED CRANKSHAFT . . .**  
Dependable, smooth operation.
- WEATHER-INSULATED IGNITION SYSTEM . . .**  
Reliable starts under all climatic conditions.

# FORD ENGINES

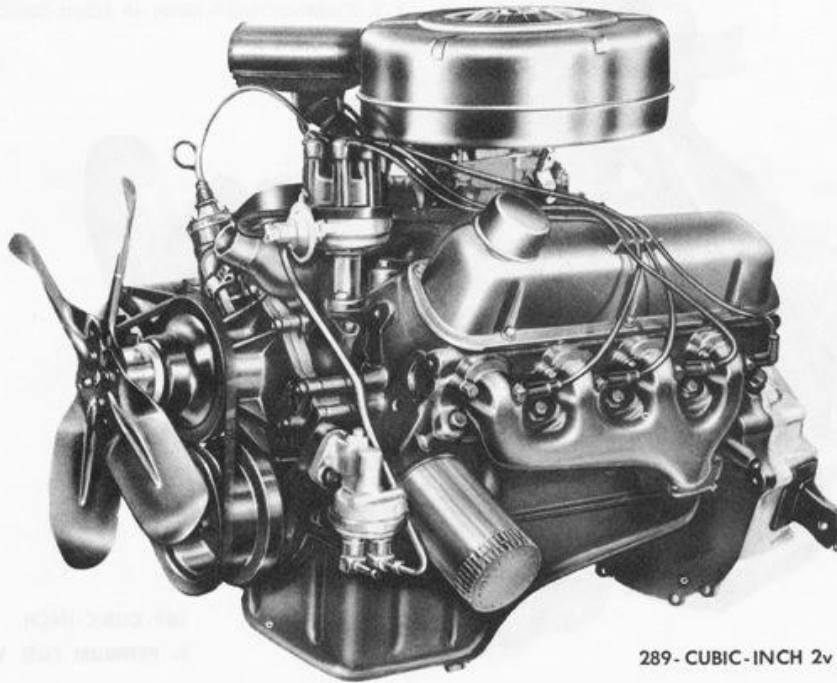

289- CUBIC-INCH 2v CHALLENGER V- 8

## GENERAL SPECIFICATIONS

Type . . . . .	8-cylinder, 90°V, overhead valve
Displacement (cubic inches) . . . . .	289
Bore and Stroke (inches) . . . . .	4.00 x 2.87
Compression Ratio . . . . .	9.3 to 1
Brake Horsepower . . . . .	200 at 4400 rpm
Maximum Torque (lbs.-ft.) . . . . .	282 at 2400 rpm
Valve Lifters . . . . .	Hydraulic
Carburetor . . . . .	Automatic choke, 2-venturi
Fuel . . . . .	Regular

## 289- CUBIC-INCH CHALLENGER 2v V-8

This engine is standard equipment on:

- Ford /XL and LTD
- Fairlane GT and GT/A

It is optional equipment on:

- All other Fords
- Mustangs
- All other Fairlanes
- Falcons, except Club Wagons

A number of important refinements have been made for 1967 to this most popular Ford V-8 engine. Under the redesigned rocker arm covers, a new valve train is introduced to improve reliability and durability while cutting maintenance intervals. New rocker arms are guided by the valves themselves, thus cutting down on close tolerances. Redesigned low inertia valve springs aid performance while cutting down on wear. In addition to this, overall performance has been improved by adding a new two-venturi carburetor.

The 289 2v is a lightweight, powerful and quiet engine that ideally suits the requirements of the smallest Falcon as well as the biggest Ford.

## QUICK FACTS

### LIGHTWEIGHT CAST IRON CONSTRUCTION . . .

Uses advanced, thin-wall casting techniques.

### SHORT STROKE DESIGN . . .

Less friction. Longer engine life.

### FULL-LENGTH, FULL-CIRCLE WATER JACKETS . . .

Uniform cylinder temperature with a minimum of "hot spots."

### AUTOTHERMIC PISTON DESIGN . . .

Maintains critical clearances required for smooth efficiency.

### HYDRAULIC VALVE LIFTERS . . .

No adjustment required.

### AUTOMATIC CHOKE . . .

Senses ambient and coolant temperatures. Helps prevent flooding on semi-warm starts.

### 2-VENTURI CARBURETOR . . .

Newly designed for improved economy and performance.

### HIGH-CAPACITY FUEL FILTER . . .

In-line design to provide maximum filtration.

### 6000-MILE OR 6-MONTH OIL FILTER . . .

Reduced maintenance and improved filtering.

### AUTOLITE POWER TIP SPARK PLUGS . . .

Self-cleaning. Extra long firing tip.

### DUAL ADVANCE DISTRIBUTOR . . .

Correct spark advance for all driving conditions.

# FORD ENGINES

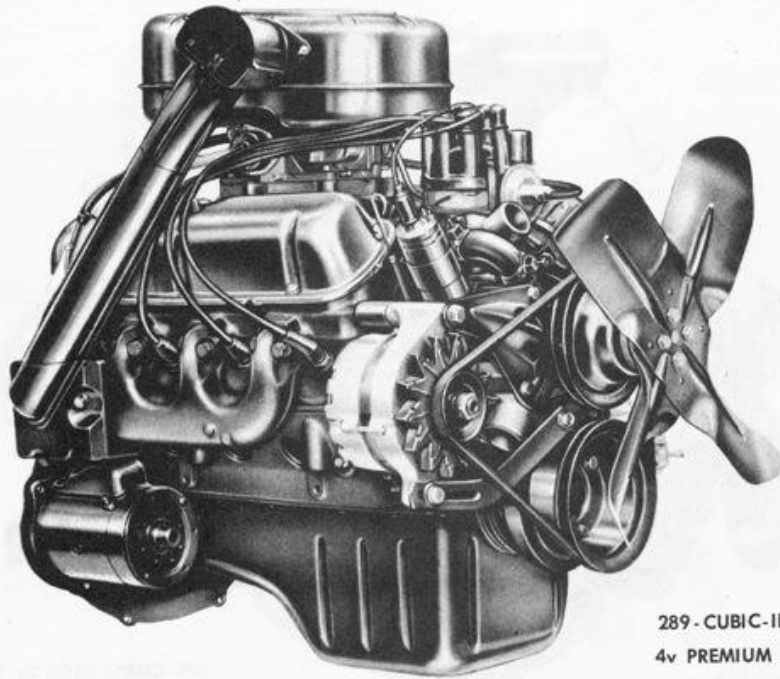

289 - CUBIC-INCH  
4v PREMIUM FUEL V-8

## GENERAL SPECIFICATIONS

Type . . . . .	8-cylinder, 90°V, overhead valve
Displacement (cubic inches) . . . . .	289
Bore and Stroke (inches) . . . . .	4.00 x 2.87
Compression Ratio . . . . .	9.8 to 1
Brake Horsepower . . . . .	225 at 4800 rpm
Maximum Torque (lbs.-ft.) . . . . .	305 at 3200 rpm
Valve Lifters . . . . .	Hydraulic
Carburetor . . . . .	Automatic choke, 4-venturi
Fuel . . . . .	Premium

## 289 - CUBIC-INCH 4v PREMIUM FUEL V-8

This engine is available as optional equipment on:

- Mustangs
- Falcons, except Club Wagons

This engine is designed to extract the most power from premium fuels and develops 225 horsepower at 4800 rpm. Similar in design to the 289 2v engine, the differences include revised valve timing, higher compression ratio and a piston design similar to that used in the High-Performance 289 V-8. The special ignition system insures the necessary spark characteristics needed to give exciting performance with reasonable economy. Also added to the 1967 model of this engine is the Autolite modified Air-Valve carburetor, which is discussed fully on page 17.

The engine features the alternate intake and exhaust valves, which improve volumetric efficiency and virtually eliminate "hot spots" which are common when exhaust valves are side by side.

## QUICK FACTS

- LOW-TENSION PISTON RINGS . . .**  
Reduces wear and provides positive sealing.
- 9.8 TO 1 COMPRESSION RATIO . . .**  
Permits most effective use of premium fuels.
- ALTERNATE VALVE SPACING . . .**  
Higher volumetric efficiency. Elimination of "hot spots" in the cylinder block and head.
- LIGHTWEIGHT CAST IRON CONSTRUCTION . . .**  
Uses advanced, thin-wall casting techniques.
- NEW AUTOLITE 4v CARBURETOR . . .**  
Modified Air-Valve design for high efficiency.
- SHORT STROKE DESIGN . . .**  
Less friction. Longer engine life.
- 36,000-MILE AIR FILTER\* . . .**  
High filtration with low maintenance.
- HIGH-CAPACITY FUEL FILTER . . .**  
In-line design to provide maximum filtration.
- FULL-LENGTH, FULL-CIRCLE WATER JACKETS . . .**  
Uniform cylinder temperature with a minimum of "hot spots."
- AUTOTHERMIC PISTON DESIGN . . .**  
Maintains critical clearances required for smooth efficiency.
- HYDRAULIC VALVE LIFTERS . . .**  
No adjustment required.
- 6000-MILE OR 6-MONTH OIL FILTER . . .**  
Reduced maintenance and improved filtering.
- DUAL ADVANCE DISTRIBUTOR . . .**  
Correct spark advance for all driving conditions.

\* 12,000 mile with closed crankcase emission system.

# FORD ENGINES

## 289-CUBIC-INCH 4v HIGH-PERFORMANCE V-8

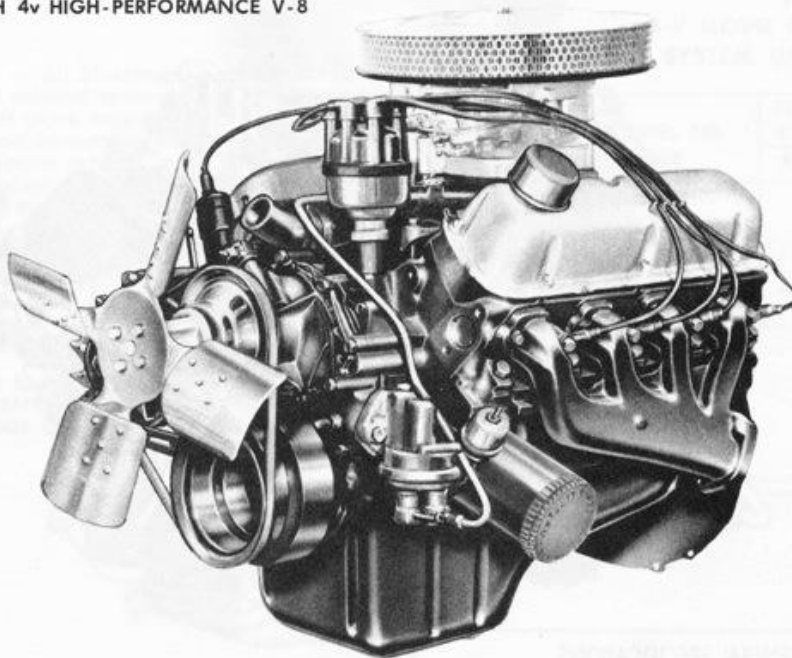

### GENERAL SPECIFICATIONS

Type . . . . .	8-cylinder, 90°V, overhead valve
Displacement (cubic inches) . . . . .	289
Bore and Stroke (inches) . . . . .	4.00 x 2.87
Compression Ratio . . . . .	10.0 to 1
Brake Horsepower . . . . .	271 at 6000 rpm
Maximum Torque (lbs.-ft.) . . . . .	312 at 3400 rpm
Valve Lifters . . . . .	Solid
Carburetor . . . . .	Manual choke, 4-venturi
Fuel . . . . .	Premium
Exhaust . . . . .	Dual

## 289-CUBIC-INCH 4v HIGH-PERFORMANCE V-8

This engine is available as optional equipment on:

- Mustangs

The engine is available with either the manual 4-speed transmission or a heavy-duty 3-speed Cruise-O-Matic automatic transmission. With its advanced engineering design and precision and thin-wall castings, this engine puts out 0.95 horsepower per cubic inch and weighs only two pounds per horsepower for unsurpassed performance in its class.

On the intake side, it features a low restriction, racing-type air cleaner, a special large bore, four-venturi carburetor and large passages in the intake manifold and cylinder heads — all designed for free breathing and high volumetric efficiency. Solid valve lifters, a special camshaft with greater valve timing overlap and a beefed up rocker arm system provide the necessary valve action for high rpm operation. The high compression cylinder heads and special pistons utilize all the power available in the premium fuel that is required for good operation.

### QUICK FACTS

- FREE-FLOW EXHAUST SYSTEM . . .**  
Large exhaust passages. Individual exhaust headers to minimize exhaust pressure. Twin pipes and mufflers.
- HIGH STRENGTH CONNECTING RODS . . .**  
Beefed up for safety and performance.
- CHROME-PLATED VALVE STEMS . . .**  
Anti-corrosion. Long life. Reduced friction.
- 10.0 TO 1 COMPRESSION RATIO . . .**  
Maximum power from premium fuels.
- SOLID VALVE LIFTERS . . .**  
Precise valve action at high rpm.
- HIGH PERFORMANCE CAMSHAFT . . .**  
Specially contoured for high lift valve opening and greater valve overlap.
- RACING-TYPE AIR CLEANER . . .**  
Low restriction for maximum efficiency under high speed conditions.
- SPECIAL IGNITION SYSTEM . . .**  
Centrifugal advance distributor.
- 6000-MILE OR 6-MONTH OIL FILTER . . .**  
Reduced maintenance and improved filtering.
- HIGH-CAPACITY FUEL FILTER . . .**  
In-line design to provide maximum filtration.
- SHORT STROKE DESIGN . . .**  
Less friction. Longer engine life.
- LIGHTWEIGHT CAST IRON CONSTRUCTION . . .**  
Uses advanced, thin-wall casting techniques.
- ALTERNATE VALVE SPACING . . .**  
Higher volumetric efficiency. Elimination of "hot spots" in cylinder block and heads.

# FORD ENGINES

390 - CUBIC-INCH  
4v THUNDERBIRD SPECIAL V-8

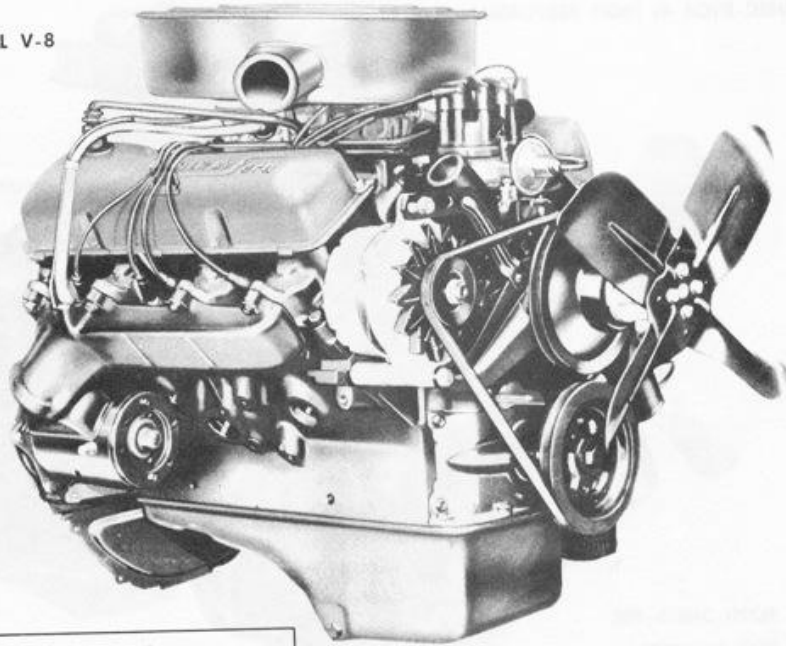

## GENERAL SPECIFICATIONS

Type . . . . .	8-cylinder, 90°V, overhead valve
Displacement (cubic inches) . . . . .	390
Bore and Stroke (inches) . . . . .	4.05 x 3.78
Compression Ratio . . . . .	10.5 to 1
Brake Horsepower . . . . .	315 at 4600 rpm
Maximum Torque (lbs.-ft.) . . . . .	320 at 4800 rpm*
	427 at 2800 rpm
	427 at 3200 rpm*
Valve Lifters . . . . .	Hydraulic
Carburetor . . . . .	Automatic choke, 4-venturi
Fuel . . . . .	Premium
Exhaust . . . . .	Dual

\* Engines used with Mustang and Fairlane GT.

## 390 - CUBIC-INCH 4v THUNDERBIRD SPECIAL V-8

The 315 horsepower version is standard equipment on:

- Thunderbird

It is optional equipment on:

- Fords

The 320 horsepower version is optional equipment on:

- Fairlanes
- Mustangs

For 1967 on the 315 horsepower version, a revised distributor calibration and the addition of the new Autolite Air-Valve carburetor gives increased volumetric efficiency and smoother, more economical operation throughout the entire speed range.

The 320 horsepower version gets its extra power a new high speed camshaft, modified valve spring larger carburetor, a special distributor and

restriction, racing-type air filter. For 1967, carburetor refinements will provide greater economy and improved cold engine operation.

## QUICK FACTS

- CHROME DRESS-UP KIT . . . . .  
Standard on 320 horsepower version. Chrome-plated air cleaner, valve covers, oil filler, dipstick and radiator cap.
- FULL-FLOW FUEL FILTER . . . . .  
In-line design to provide maximum filtration.
- HIGH-PERFORMANCE VALVE SPRINGS AND DAMPER ASSEMBLY . . . . .  
Greater resistance to fatigue and wear.
- 6000-MILE OR 6-MONTH OIL FILTER . . . . .  
Reduced maintenance and improved filtering.
- 10.5 TO 1 COMPRESSION RATIO . . . . .  
Maximum power from premium fuels.
- NEW CAMSHAFT LOBE PROFILE . . . . .  
More usable torque with a smooth idle.
- DUAL ADVANCE DISTRIBUTOR . . . . .  
Correct spark advance for all driving conditions.
- LIGHTWEIGHT CAST IRON CONSTRUCTION . . . . .  
Uses advanced, thin-wall casting techniques.
- ALTERNATE VALVE SPACING . . . . .  
Higher volumetric efficiency. Elimination of "hot spots" in cylinder block and head.
- FREE-FLOW EXHAUST SYSTEM . . . . .  
Large exhaust passages. Individual exhaust headers to minimize exhaust pressure. Twin pipes and mufflers.
- ROCKE DESIGN . . . . .  
on. Longer engine life.
- ACILITY OIL SUMP . . . . .  
rt design gives better circulation and cooling.

# ENGINE EXHAUST SYSTEMS

**MUSTANG** — All Mustang GT models are equipped with a dual exhaust system. This system consists of dual exhaust pipes, and equalizer pipe, dual "node" chambers and resonators, dual exhaust outlet pipes, and dual chrome exhaust outlet tips extending under the rear modesty panel. This same system, with the exception of the chrome exhaust tips, is included on all other Mustangs equipped with the 289-cubic-inch High-Performance V-8. All other Mustangs are equipped with a single exhaust system.

## EXHAUST SYSTEM USAGE

CAR MODEL AND ENGINE	EXHAUST SYSTEM	
	A	B
<b>MUSTANG</b>		
200 Six		X
289 2v V-8		X
289 4v V-8		X
289 High-Perf. V-8	X	
390 4v V-8	X	

**A — DUAL EXHAUST SYSTEM WITH CROSSOVER, SINGLE TRANSVERSE-MOUNTED MUFFLER AND DUAL NODE CHAMBER**

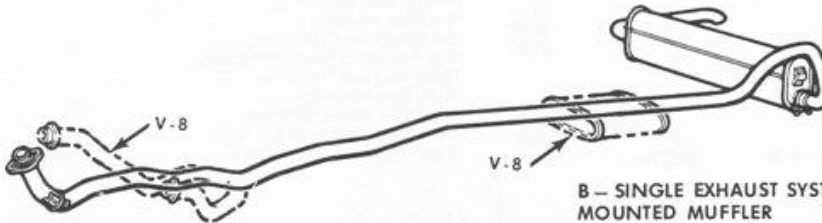
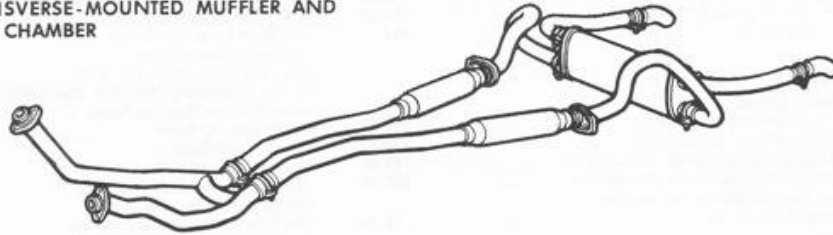

**B — SINGLE EXHAUST SYSTEM WITH TRANSVERSE-MOUNTED MUFFLER**

# 1967 MUSTANG PRICES

Effective Date January 1, 1967

MUSTANG MODELS	SUGGESTED RETAIL	COMFORT-CONVENIENCE EQUIPMENT (continued)	SUGGESTED RETAIL
2-Door Hardtop .....	\$2461.46	Competition Handling Package (with GT Equip. Group only) .....	388.53
Convertible .....	2698.14	Tinted Windows and Windshield .....	30.25
2 + 2 Fastback .....	2592.17	Convenience Control Panel .....	39.50
<b>REGULAR PRODUCTION OPTIONS</b>		Fingertip Speed Control (Requires V8 & Cruise-O-Matic) .....	71.30
<b>ENGINES</b>		Remote-Control Outside Mirror (Std. 2 + 2) .....	9.58
289-cu. in. 200-HP V8 .....	105.65	Convertible Safety Glass Rear Window .....	32.44
289-cu. in. 225-HP V8 .....	158.48	SelectAire Conditioner .....	356.09
289-cu. in. 271-HP V8 (with GT Equip. Only) .....	433.55	Push-Button Radio AM .....	57.51
390-cu. in. 320-HP V8 .....	263.71	Push-Button Radio AM/FM .....	133.65
<b>TRANSMISSIONS</b>		Stereo-Sonic Tape System (AM Radio Required) .....	128.49
Cruise-O-Matic with six .....	188.18	2 + 2 Folding Rear Seat and Access Door (Sport Deck Option) .....	64.77
Cruise-O-Matic with 200 or 225 HP V8 .....	197.89	Full-Width Front Seat (N.A. 2 + 2) .....	24.42
Cruise-O-Matic with 271 or 320 HP V8 .....	220.17	Tilt-Away Steering Wheel .....	59.93
4-Speed Manual Transmission W/200 or 225 HP .....	184.02	Rear Deck Luggage Rack (2 + 2) .....	32.44
4-Speed Manual Transmission W/all other V8s .....	233.18	Comfort Weave Vinyl Trim (N.A. Convertible) .....	24.53
Heavy Duty 3-Speed Manual Transmission .....		Center Console (Requires Radio) .....	50.41
Required with 320 HP V8 .....	79.20	Deluxe Steering Wheel .....	31.52
<b>POWER ASSISTS</b>		Exterior Decor Group .....	38.86
Power Front Disc Brakes .....	64.77	Lower Back Panel Grille .....	19.48
Power Steering .....	84.47	Interior Decor Group (Convertible) .....	94.36
Power Convertible Top .....	52.95	Interior Decor Group (All Others) .....	108.06
<b>COMFORT-CONVENIENCE EQUIPMENT</b>		Two Tone Paint (Lower Back Grille) .....	12.95
GT Equipment Group (with V8s only) .....	205.05	Accent Paint Stripes .....	13.90
Limited-Slip Differential .....	41.60	Vinyl-Covered Roof (Hardtop) .....	74.36
Styled-Steel Wheels (2 + 2 only) 93.84 .....	115.11	Wheel Covers (Std. 2 + 2) .....	21.34
		Wire Wheel Covers (2 + 2) .....	58.24
		Wire Wheel Covers (All Others) .....	79.51
		Wide-Oval Sports Tires (V8 Required) .....	62.35
		Typical Whitewall Tire Option .....	33.31
		Styled Steel Wheels (2 + 2) .....	93.84
		Styled Steel Wheels (All Others) .....	115.11
		Rocker Panel Molding (Std. 2 + 2) .....	15.59
		MagicAire Heater (Delete Option) .....	(31.52)